

**SEPARATELY EXCITED TRANSISTORIZED TRACTION CONTROL
INSTALLATION AND OPERATION MANUAL**
IC3645SR7T405TA5

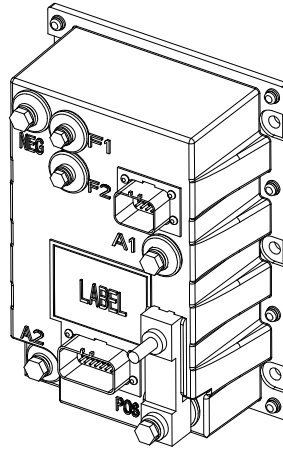

Note: The information contained herein is intended to assist OEM's, Dealers and Users of electric vehicles in the application, installation and service of Flight Systems solid-state controllers. This manual does not purport to cover all variations in OEM vehicle types. Nor does it provide for every possible contingency to be met involving vehicle installation, operation or maintenance. For additional information and/or problem resolution, please refer the matter to the OEM vehicle manufacturer through his normal field service channels. Do not contact Flight Systems directly for this assistance.

Table of Contents

Flight Systems Industrial Products July 2012

Section 1.0	INTRODUCTION	4
1.1	Motor Characteristics	4
1.2	Solid-State Reversing	5
1.3	Flexible System Application	5
1.4	More Features with Fewer Components	5
Section 2.0	FEATURES OF IT FAMILY OF MOTOR CONTROLLERS.....	6
2.1	Performance	6
2.1.1	Oscillator Card Features.....	6
2.1.1.a	Standard Operation	6
2.1.1.b	Creep Speed	6
2.1.1.c	Control Acceleration	6
2.1.2	Current Limit	6
2.1.3	Braking.....	6
2.1.3.a	Regenerative Braking to Zero Speed.....	6
2.1.3.b	Pedal Position Plug Braking.....	6
2.1.3.c	Auto Braking.....	6
2.1.4	Auxiliary Speed Control	6
2.1.4.a	Field Weakening	6
2.1.4.b	Speed Limits	7
2.1.5	Ramp Operation	7

Table of Contents (Continued)

2.1.5.a	Ramp Start	7
2.1.5.b	Anti-Rollback	7
2.1.6	On-Board Coil Drivers and Internal Coil Suppression	7
2.2	System Protective Override	7
2.2.1	Static Return to Off (SRO)	7
2.2.2	Accelerator Volts Hold Off	7
2.2.3	Pulse Monitor Trip (PMT).....	7
2.2.4	Thermal Protector (TP).....	7
2.2.5	Low Voltage	7
2.2.6	Motor Thermal Switch Input.....	7
2.3	Diagnostics.....	8
2.3.1	Systems Diagnostics.....	8
2.3.2	Status Codes.....	8
2.3.2.a	Standard Status Codes.....	8
2.3.2.b	Stored Status Codes	8
2.3.3	Hourmeter Readings	8
2.3.4	Battery Discharge Indication (BDI).....	8
2.3.4.a	Internal Resistance Compensation	8
2.3.5	Handset	8
2.3.6	RS-232 Communication Port	8
2.3.7	Circuit Board Coil Driver Modules.....	8
Section 3.0	ORDERING INFORMATION, ELEMENTARY AND OUTLINE DRAWINGS.....	9
3.1	Ordering Information for Separately Excited Controls.....	9
3.2	Outline: IT400 Package Size	10
3.3	Traction Elementary.....	11
3.4	Traction Control Input / Output List.....	12
Section 4.0	TROUBLESHOOTING AND DIAGNOSTIC STATUS CODES	13
4.1	General Maintenance Instructions.....	13
4.2	Cable Routing and Separation	13
4.2.1	Application Responsibility	13
4.2.2	Signal/Power Level Definitions.....	13
4.2.2.a	Low Level Signals (Level L).....	14
4.2.2.b	High Level Signals (Level H)	14
4.2.2.c	Medium-Power Signals (Level MP)	14
4.2.2.d	High-Power Signals (Level HP)	14
4.2.3	Cable Spacing Guidelines.....	14
4.2.3.a	General Cable Spacing.....	14
4.2.4	Cabling for Vehicle Retrofits.....	14
4.2.5	RF Interference	15
4.2.6	Suppression	15
4.3	Recommended Lubrication of Pins and Sockets Prior to Installation.....	15
4.4	Controller Mounting Guidelines	16
4.4.1	Necessary Tools.....	16
4.4.2	The Flight Systems Control Mounting Surface	16
4.4.3	Vehicle Mounting Surface	16
4.4.4	Application of Thermal Compound.....	17
4.4.5	Mounting the Flight Systems Control	17
4.4.6	Maintenance.....	18
4.5	General Troubleshooting Instructions.....	18
4.6	Traction Controller Status Codes	18-35

Table of Contents (Continued)

Section 5.0	IT FAMILY - GE HANDSET INSTRUCTIONS	36
5.1	General Features	36
5.2	Purpose/Setup Functions	36
5.3	Setup Function Procedures	37
5.3.1	Setup Mode	37
5.3.2	Status Code Scrolling.....	37
5.3.3	IT Handset Plug Connections & Outline Drawing....	37
5.4	Setup Functions for Traction Controller	38-41
5.5	Summary of Current Limit Adjustments	42
Section 6.0	MEMORY MAPS	43
6.1	Traction Control	43-45

Section 1. INTRODUCTION

Section 1.1 Motor Characteristics

The level of sophistication in the controllability of traction motors has changed greatly over the past several years. Vehicle manufacturers and users are continuing to expect more value and flexibility in electric vehicle motor and control systems as they are applied today. In order to respond to these market demands, traction system designers have been forced to develop new approaches to reduce cost and improve functions and features of the overall system. Development is being done in a multi-generational format that allows the market to take advantage of today's technology, while looking forward to new advances on the horizon. The separately excited DC motor system offers many of the features that are generally found on the advanced AC systems. Historically, most electric vehicles have relied have on series motor designs because of their ability to produce very high levels of torque at low speeds. But, as the demand for high efficiency systems increases, i.e., systems that are more closely applied to customers' specific torque requirements, shunt motors are now often being considered over series motors. In most applications, by independently controlling the field and armature currents in the separately excited motor, the best attributes of both the series and the shunt wound motors can be combined.

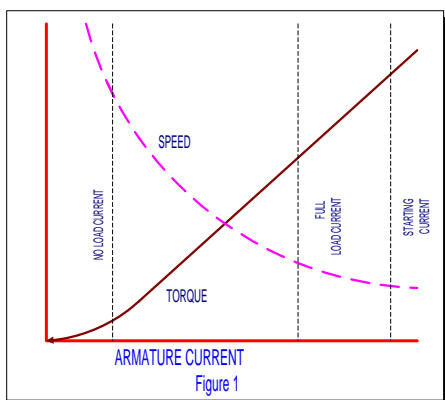

As shown in from the typical performance curves of Figure 1, the high torque at low speed characteristic of the series motor is evident.

In a shunt motor, the field is connected directly across the voltage source and is therefore independent of variations in load and armature current. If field strength is held constant, the torque developed will vary directly with the armature current. If the mechanical load on the motor increases, the motor slows down, reducing the back EMF (which depends on the speed, as well as the constant field

strength). The reduced back EMF allows the armature current to increase, providing the greater torque needed to drive the increased mechanical load. If the mechanical load is decreased, the process reverses. The motor speed and the back EMF increase, while the armature current and the torque developed decrease. Thus, whenever the load changes, the speed changes also, until the motor is again in electrical balance.

In a shunt motor, the variation of speed from no load to normal full load on level ground is less than 10%. For this reason, shunt motors are considered to be constant speed motors (Figure 2).

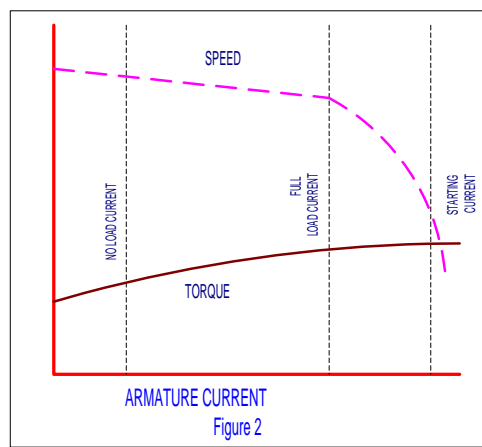

In the separately excited motor, the motor is operated as a fixed field shunt motor in the normal running range. However, when additional torque is required, for example, to climb non-level terrain, such as ramps and the like, the field current is increased to provide the higher level of torque. In most cases, the armature to field ampere turn ratio can be very similar to that of a comparable size series motor (Figure 3.)

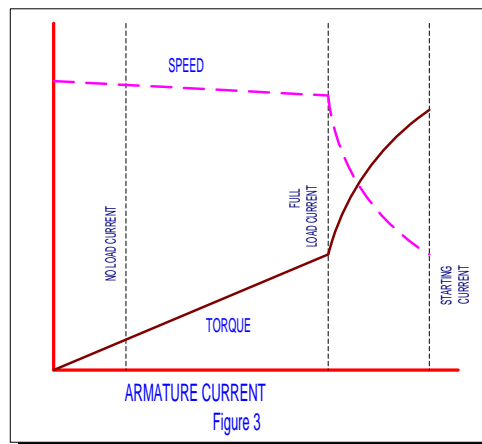

Aside from the constant horsepower characteristics described above, there are many other features that

provide increased performance and lower cost. The following description provides a brief introduction to examples of some of these features.

Section 1.2 Solid-State Reversing

The direction of armature rotation on a shunt motor is determined by the direction in which current flows through the field windings. Because of the of the shunt motor field only typically requires about 10% of the armature current at full torque, it is normally cost effective to replace the double-pole, double-throw reversing contactor with a low power transistor H-Bridge circuit (Figure 4).

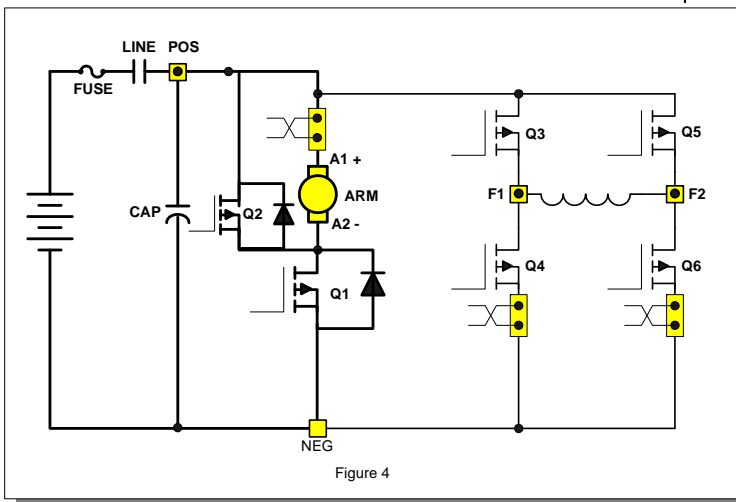

By energizing the transistors in pairs, current can be made to flow in either direction in the field. The armature control circuit typically operates at 12KHZ to 15KHZ, a frequency range normally above human hearing. This high frequency coupled with the elimination of directional contactors, provides very quiet vehicle operation. The field control circuits typically operate at 2 KHZ.

The line contactor is normally the only contactor required for the shunt motor traction circuit. This contactor is used for both pre-charge of the line capacitors and for emergency shut down of the motor circuit, in case of problems that would cause a full motor torque condition. The line can be energized and de-energized by the various logic combinations of the vehicle, i.e. activate on key, seat or start switch closure, and de-energize on time out of idle vehicle. Again, these options add to the quiet operation of the vehicle.

Section 1.3 Flexible System Application

Because the shunt motor controller has the ability to control both the armature and field circuits

independently, the system can normally be adjusted for maximum system efficiencies at certain operating parameters. Generally speaking, with the ability of independent field and armature, the motor performance curve can be maximized through proper control application.

Section 1.4 More Features with Fewer Components

Field weakening with a series wound motor is accomplished by placing a resistor in parallel with the field winding of the motor. Bypassing some of the current flowing in the field into the resistor causes the field current to be less, or weakened. With the field weakened, the motor speed will increase, giving the effect of "overdrive". To change the "overdrive speed", it is necessary to change the resistor value. In a separately excited motor, independent control of the field current provides for infinite adjustments of "overdrive" levels, between motor base speed and maximum weak field. The desirability of this feature is enhanced by the elimination of the contactor and resistor required for field weakening with a series motor.

With a separately excited motor, overhauling speed limit, or downhill speed, will also be more constant. By its nature, the shunt motor will try to maintain a constant speed downhill. This characteristic can be enhanced by increasing the field strength with the control. Overhauling load control works in just the opposite way of field weakening, armature rotation slows with the increase of current in the field.

Regenerative braking (braking energy returned to the battery) may be accomplished completely with solid-state technology. The main advantage of regenerative braking is increased motor life. Motor current is reduced by 50% or more during braking while maintaining the same braking torque as electrical braking with a diode clamp around the armature. The lower current translates into longer brush life and reduced motor heating. Solid state regenerative braking also eliminates a power diode, current sensor and contactor from the circuit.

Section 2. FEATURES OF IT FAMILY OF TRANSISTOR MOTOR CONTROLLERS

Section 2.1 Performance

Section 2.1.1 Oscillator Card Features

Section 2.1.1.a Standard Operation

With the accelerator at maximum ohms or volts, the creep speed can be adjusted by Function 2 of the Handset or a trimpot. The field control section allows the adjustment of the field weakening level in order to set the top speed of the motor. This top speed function (Minimum Field Current) is enabled when the armature current is less than the value set by Function 24 and the accelerator output voltage is greater than 3.5 volts. Top Speed can be adjusted by Function 7 of the Handset or a trimpot.

The percent on-time has a range of approximately 0 to 100 percent. The IT controllers operate at a constant frequency and the percent on-time is controlled by the pulse width of the voltage / current applied to the motor circuits.

Section 2.1.1.b Creep Speed

With the accelerator at minimum ohms or volts (approximately 0.0 to 0.5 VDC), the creep speed can be adjusted by Function 2 of the Handset. At creep speed, the ON time can decrease to approximately 5%, with the OFF time at approximately 95%. At full transistor operation, this condition will be reversed (short OFF time, long ON time). This variation of ON and OFF time of the oscillator varies the voltage applied to the motor, thereby varying the speed of the motor for a given load.

Section 2.1.1.c Control Acceleration

This feature allows for adjustment of the rate of time it takes for the control to accelerate to 100% applied battery voltage to the motor on hard acceleration. Armature C/A is adjusted by Function 3 from 0.1 to 22 seconds.

Section 2.1.2 Current Limit

This circuit monitors motor current by utilizing sensors in series with the armature and field windings. The information detected by the sensor is fed back to the card so that current may be limited to a pre-set value. If heavy load currents are detected, this circuit overrides the oscillator and limits the average current to a value set by Function 4 and Function 8 of the Handset. The C/L setting is based on the maximum thermal rating of the control. Because of the flyback current through 3REC, the

motor current is usually greater than battery current, except at 100% ON time.

Section 2.1.3 Braking

Section 2.1.3.a Regenerative Braking to Zero Speed

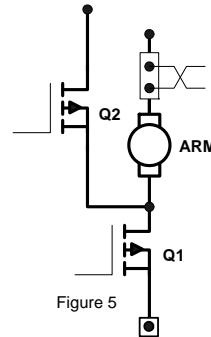

Slow down is accomplished when reversing direction by providing a small amount of retarding torque for deceleration. If the vehicle is moving, and the directional lever is moved from one direction to the other, the regen signal is initiated. Once the regen signal has been initiated, the field current is increased (armature circuit shown in Figure

5). Armature current is regulated to the regen current limit as set by Function 9. As the vehicle slows down, the field current continues to increase, and transistor Q2 begins to chop. The field current will increase until it reaches a preset value set by Function 10, and transistor Q2 on-time will increase until it reaches 100% on-time. Once both of the above conditions have been met, and regen current limit can no longer be maintained, the braking function is canceled. The fields will then reverse, and the control reverts back to motoring.

Part of the energy produced by the motor during regen is returned to the battery, and part is dumped in the motor as heat.

Section 2.1.3.b Pedal Position Plug Braking

This feature allows control of the plugging distance based on pedal position when there has been a "directional switch" change. Pedal position will reduce the regenerative current to the "value set by this function" as the accelerator is returned to the creep speed position. Maximum regen current is obtained with the accelerator in the top speed position.

Section 2.1.3.c Auto Braking

This feature is enabled by initiating a "neutral position" using either the directional switch or the accelerator switch. Once activated, Auto Braking operates similar to Pedal Position Plug Braking and is adjusted by using Function 21 of the Handset.

Section 2.1.4 Auxiliary Speed Control

Section 2.1.4.a Field Weakening

This function allows the adjustment of the field weakening level in order to set the top speed of the motor. The function is enabled when the armature current is less than the value set by Function 24 and the accelerator input voltage is less than 1 volt. It is important to note that this function is used to optimize

motor and control performance, and this setting will be determined by Flight Systems and OEM engineers at the time of vehicle development. This setting must not be changed by field personnel, without the permission of the OEM.

Section 2.1.4.b Speed Limits

This feature provides a means to control speed by limiting motor volts utilizing three "adjustable speed limits. This motor volt limit regulates top speed of the transistor controller, but actual truck speed will vary at any set point depending on the loading of the vehicle. Each speed limit can be adjustable with the Handset using Functions 11, 12, and 13.

Section 2.1.5 Ramp Operation

Section 2.1.5a Ramp Start

This feature provides maximum control torque to restart a vehicle on an incline. The memory for this function is the directional switch. When stopping on an incline, the directional switch must be left in its original or neutral position to allow the control to initiate full power when restarted. The accelerator potentiometer input will modulate ramp start current.

Section 2.1.5b Anti-Rollback

This feature provides retarding torque to limit rollback speed in the non-travel direction when the ACC pedal is released when stopping on a grade, or when the brake pedal is released when starting on a grade. This feature forces the vehicle to roll very slowly down the grade when accelerator or brake is released. Because the vehicle can gain significant speed during roll-back, the torque needed to re-start on the ramp is lower than an unrestricted roll-back speed.

Section 2.1.6 On-Board Coil Drivers & Internal Coil Suppression

Coil drivers for the LINE contactor and BRAKE are on-board the control card. These accessories must have coils rated for the vehicle battery volts.

Section 2.2 System Protective Override

Section 2.2.1 Static Return to Off (SRO)

This inherent feature of the control is designed to require the driver to return the directional lever to the neutral position anytime the operator switches the key switch off.

Section 2.2.2 Accelerator Volts Hold Off

This feature checks the voltage level at the accelerator input whenever the key switch or seat switch is activated. If, at start up, the voltage is less than 3.0 volts, the control will not operate. This

feature assures that the control is calling for low speed operation at start up.

Section 2.2.3 Pulse Monitor Trip (PMT)

The PMT design contains three features which shut down, or lock out, control operation if a fault conditions occurs that would cause a disruption of normal vehicle operation:

- Look ahead
- Look again
- Automatic look again and reset

The PMT circuit will not allow the control to start under the following conditions:

- The control monitors both armature and field FET's at start-up and during running.
- The control will not allow the line contactor to close at start-up, or will drop it out during running, if either the armature or field FET's are defective, so as to cause uncontrolled truck movement.

Section 2.2.4 Thermal Protector (TP)

This temperature sensitive device is internal to the power transistor (Q1) module. If the transistor's temperature begins to exceed the design limits, the thermal protector will lower the maximum current limit, and maintain the transistors within their temperature limits. Even at a reduced current limit, the vehicle will normally be able to reach sufficient speed. As the control cools, the thermal protector will automatically reset, returning the control to full power.

Section 2.2.5 Low Voltage

Batteries under load, particularly if undersized or more than 80 percent discharged, will produce low voltages at the control terminals. The IT control is designed for use down to 50 percent of a nominal battery voltage of 36-84 volts, and 75 percent of a nominal battery voltage of 24 volts. Lower battery voltage may cause the control to operate improperly, however, the resulting PMT should open the Line contactor, in the event of a failure.

Section 2.2.6 Motor Thermal Switch Input

Some motors are equipped with a thermal protector, a normally closed switch that opens when the motor has reached its thermal limit. This feature monitors this switch and once open the control provides reduced current to the motor to allow the motor to maintain a safe temperature. This feature's current limit is adjustable with TT1J firmware and later. Older revisions of firmware have a fixed current limit.

Section 2.3 Diagnostics

Section 2.3.1 Systems Diagnostics

The control detects the system's present operating status and can be displayed to either the Dash Display or the Handset. There are currently over 70 status codes that are available with IT systems using Traction and Pump controls and Truck Management Module (TMM). The IT control is capable of reducing the current to the motor, alerting the operator of a critical fault condition.

Section 2.3.2 Status Codes

Section 2.3.2a Standard Status Codes

The IT traction control has over 30 Status Codes that assist the service technician and operator in trouble shooting the vehicle. If mis-operation of the vehicle occurs, a status code will be displayed on the Dash Display for vehicles so equipped, or be available by plugging the Handset into the "Y" plug of the logic card.

With the status code number, follow the procedures outlined in DIAGNOSTIC STATUS CODES to determine the problem and a solution.

Note: The Status Code Instruction Sheets do not claim to cover all possible causes of a display of a "status code ". They do provide instructions for checking the most direct inputs that can cause status codes to appear.

Section 2.3.2.b Stored Status Codes

This feature records the last 16 "Stored Status Codes" that have caused a PMT controller shut down and/or disrupted normal vehicle operation. (PMT type faults are reset by cycling the key switch). These status codes, along with the corresponding BDI and hourmeter readings, can be accessed with the Handset, or by using the RS 232 communications port and dumping the information to a Personal Computer terminal.

Section 2.3.3 Hourmeter Readings

N/A

Section 2.3.4 Battery Discharge Indication (BDI)

The latest in microprocessor technology is used to provide accurate battery state of charge information

and to supply passive and active warning signals to the vehicle operator. Features and functions:

- Displays 100 to 0 percent charge.
- Display blinks with 10% charge. Auto ranging for 36/48 volt operation. Adjustable for use on 24 to 80 volts.

Section 2.3.4.a Internal Resistance Compensation

This feature is used when the Battery Discharge Indicator is present. Adjustment of this function will improve the accuracy of the BDI.

Section 2.3.5 Handset

This is a multi-functional tool used with the LX, ZX, SX and IT Series GE solid state controls. The Handset consists of a Light Emitting Diode (LED) display and a keyboard for data entry. Note, for ordering purposes, a separate Handset part is required for IT controls.

Features and functions:

- Monitor existing system status codes for both traction and pump controls. Monitor intermittent random status codes.
- Monitor battery state of charge, if available.
- Monitor hourmeter reading on traction and pump controls. Monitor or adjust the control functions.

Section 2.3.6 RS 232 Communication Port

This serial communication port can be used with Interactive Custom Dash Displays to allow changes to vehicle operating parameters by the operator. Or, it can be used by service personnel to dump control operating information and settings into a personal computer program.

Section 2.3.6.a Performance Mode Selection

N/A

Section 2.3.7 Circuit Board Coil Driver Modules

Coil drivers are internal to the control card, and are the power devices that operate the Line contactor and brake coils. On command from the control card, these drivers initiate opening and closing the coils. All driver modules are equipped with reverse battery protection, such that, if the battery is connected incorrectly, the contactors can not be closed electrically.

Section 3.0 ORDERING INFORMATION, ELEMENTARY AND OUTLINE DRAWINGS

Section 3.1 Ordering Information for Separately Excited Controls

Example:

Part Number: IC3645 SH 4 D 33 2 C3
Argument Number: 01 02 03 04 05 06 07

Argument 01: Basic Electric Vehicle Control Number

Argument 02: Control Type:

SP = Series Control (Pump)
 SH = Separately Excited Control (Plugging)
 SR = Separately Excited Control (Regen to Zero)

Argument 03: Operating Voltage:

1 = 120 volts	4 = 48 volts
2 = 24 volts	5 = 36/48 volts
3 = 36 volts	6 = 24/36 volts
7 = 72/80 volts	

Argument 04: Package Size:

D = 6.86" X 6.67"
 R = 6.86" X 8.15"
 T = 9.63" X 7.05"
 U = 8.66" X 8.13"
 W = 8.66" X 10.83"

Argument 05: Armature Current
 (2 characters)

22 = 220 Amps
 33 = 330 Amps
 40 = 400 Amps
 etc.

Argument 06: Field Current
 (1 character)

2 = 20 Amps
 3 = 30 Amps
 4 = 40 Amps
 etc.

Argument 07: Customer / Revision

A1 = Customer A / Revision 1
 B1 = Customer B / Revision 1
 etc.

Section 3.2 Outline: IT400 Package

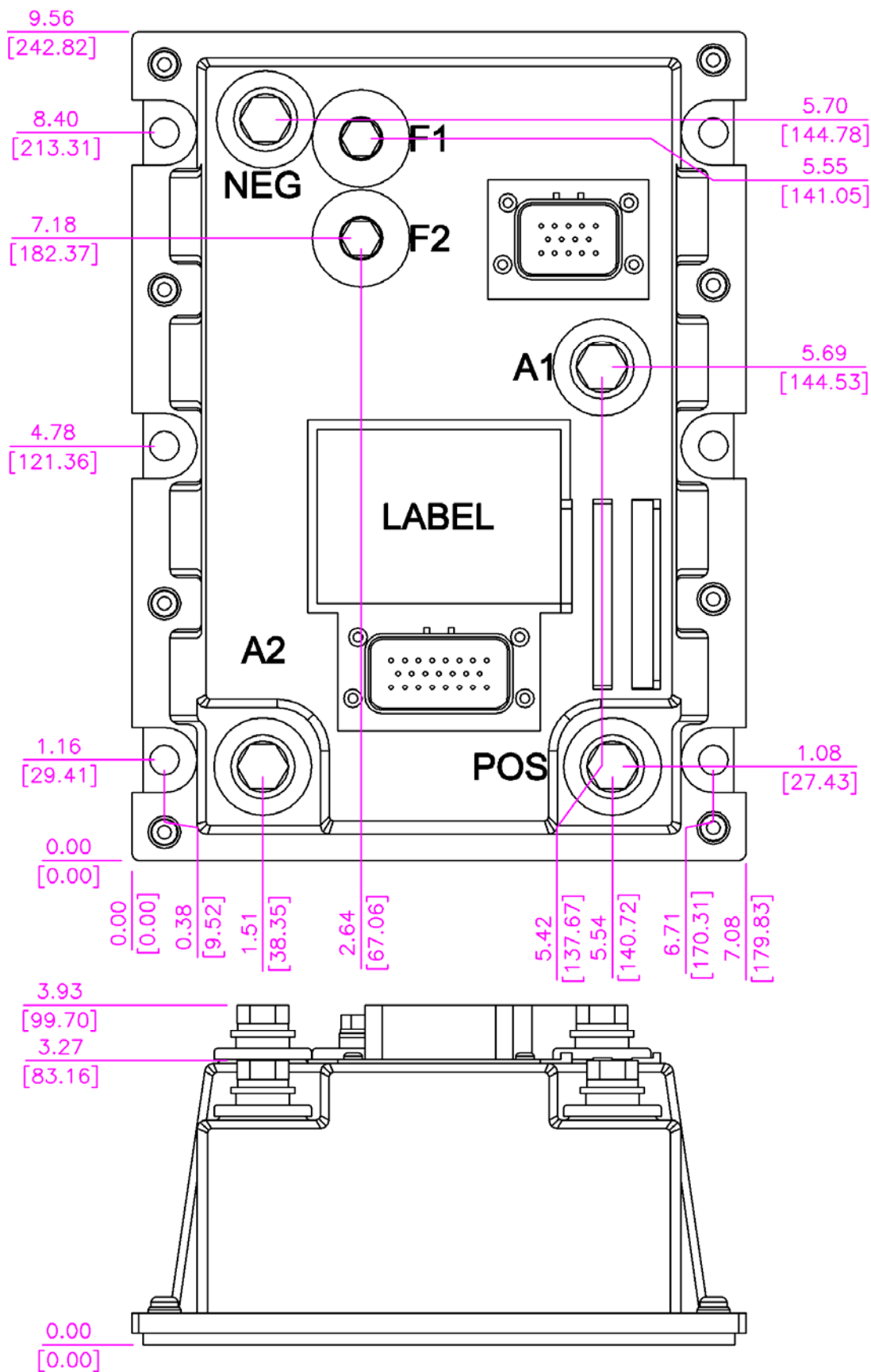

Section 3.3 Traction Elementary

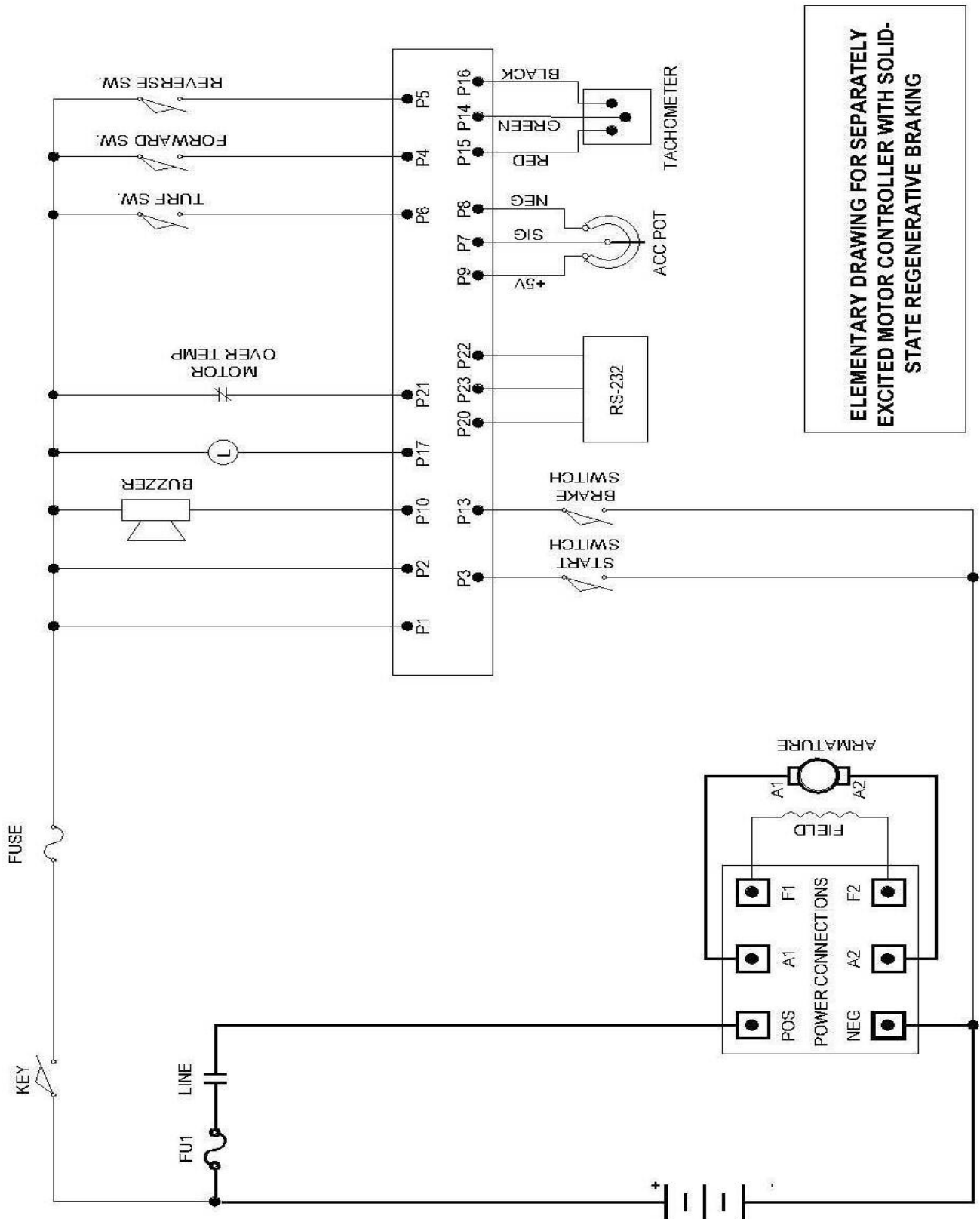

Section 3.4. Traction Control Input and Output List

PIN	INPUT/OUTPUT DESCRIPTION
1	BATTERY VOLTS FROM BATTERY
2	BATTERY VOLTS FROM KEY
3	BATTERY NEG FROM START SWITCH
4	BATTERY VOLTS FROM FORWARD SWITCH
5	BATTERY VOLTS FROM REVERSE SWITCH
6	BATTERY VOLTS FROM TURF SWITCH
7	ACCELERATOR INPUT VOLTAGE SIGNAL
8	POT NEGATIVE
9	POT +5 VOLTS SUPPLY
10	BUZZER
11	PLUG/RGN OUTPUT SIGNAL +12V 1.0V=REGEN
12	NOT USED
13	BATTERY NEG PARK BRAKE SW
14	TACH INPUT
15	TACH +12V
16	TACH NEG
17	LINE CONTACTOR DRIVER AND SUPPRESSION
18	NOT USED
19	NOT USED
20	SENTRY NEG
21	MOTOR TEMP SW
22	SERIAL RECEIVE / DASH DISPLAY
23	SERIAL TRANSMIT / DASH DISPLAY
PIN	MOTOR PROPORTIONING "Y" PLUG INPUT/OUTPUT DESCRIPTION
1	CLOCK (OUT)
2	DATA (OUT)
3	ENABLE (OUT)
4	NEGATIVE
5	+5V SUPPLY
6	CONT/STORE (IN) (HANDSET)
7	NOT USED
8	VALUE
9	FUNCTION
10	NOT USED
11	SERIAL RECEIVE / CONNECT TO P22
12	SERIAL TRANSMIT / CONNECT TO P23
13	NOT USED
14	NOT USED

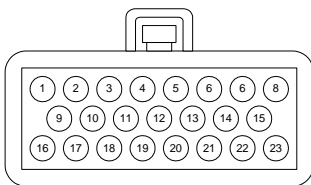

WIRE END VIEW – MAIN PLUG

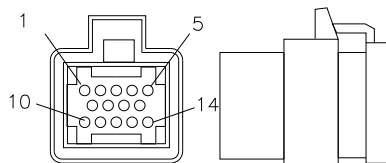

WIRE END VIEW "Y" PLUG

Section 4.0 TROUBLESHOOTING AND DIAGNOSTIC STATUS CODES

Section 4.1 General Maintenance Instructions

The transistor control, like all electrical apparatus, does have some thermal losses. The semiconductor junctions have finite *temperature* limits, above which these devices may be damaged. For these reasons, normal maintenance should guard against any action which will expose the components to excessive heat and/or those conditions which will reduce the heat dissipating ability of the control, such as restricting air flow.

The following Do's and Don'ts should be observed:

Any controls that will be applied in ambient temperatures over 100° F (40° C) should be brought to the attention of the vehicle manufacturer.

All external components having inductive coils must be filtered. Refer to vehicle manufacturer for specifications.

The wiring should not be directly steam cleaned. In dusty areas, blow low-pressure air over the control to remove dust. In oily or greasy areas, a mild solution of detergent or denatured alcohol can be used to wash the control, and then low-pressure air should be used to completely dry the control.

For the control to be most effective, it must be mounted against the frame of the vehicle. The metal vehicle frame, acting as an additional heat sink, will give improved vehicle performance by keeping the control package cooler. *Apply a thin layer of heat-transfer grease (such as Dow Corning 340) between the control heat sink and the vehicle frame.*

Control wire plugs and other exposed transistor control parts should be kept free of dirt and paint that might change the effective resistance between points.

CAUTION: The vehicle should not be plugged when the vehicle is jacked up and the drive wheels are in a free wheeling position. The higher motor speeds can create excessive voltages that can be harmful to the control.

Do not hipot (or megger) the control. Refer to control manufacturer before hipotting.

Use a lead-acid battery with the voltage and ampere hour rating specified for the vehicle. Follow normal

battery maintenance procedures, recharging before 80 percent discharged with periodic equalizing charges.

Visual inspection of Flight Systems contactors contained in the traction and pump systems is recommended to occur during every 1000 hours of vehicle operation. Inspection is recommended to verify that the contactors are not binding and that the tips are intact and free of contaminants.

Flight Systems does not recommend that any type of welding be performed on the vehicle after the installation of the control(s) in the vehicle. Flight Systems will not honor control failures during the warranty period when such failures are attributed to welding while the control is installed in the vehicle.

Section 4.2 Cable Routing and Separation

Electrical noise from cabling of various voltage levels can interfere with a microprocessor-based control system. To reduce this interference, Flight Systems recommends specific cable separation and routing practices, consistent with industry standards.

Section 4.2.1 Application Responsibility

The customer and customer's representative are responsible for the mechanical and environmental locations of cables. They are also responsible for applying the level rules and cabling practices defined in this section.

To help ensure a lower cost, noise-free installation, Flight Systems recommends early planning of cable routing that complies with these level separation rules.

On new installations, sufficient space should be allowed to efficiently arrange mechanical and electrical equipment.

On vehicle retrofits, level rules should be considered during the planning stages to help ensure correct application and a more trouble-free installation.

Section 4.2.2 Signal/Power Level Definitions

The signal/power carrying cables are categorized into four defining levels: low, high, medium power, and high power. Within those levels, signals can be further divided into classes.

Sections 4.2.2.a through 4.2.2.d define these levels and classes, with specific examples of each. Section 4.2.3 contains recommendations for separating the levels.

4.2.2.a Low-Level Signals (Level L)

Low-level signals are designated as *level L*. These consist of:

- Analog signals 0 through ± 15 V
- Digital signals whose logic levels are less than 15 V DC
- 4 – 20 mA current loops
- DC busses less than 15 V and 250 mA

The following are specific examples of level L signals used in drive equipment cabling:

- Control common tie
- DC busses feeding sensitive analog or digital hardware
- All wiring connected to components associated with sensitive analog hardware with less than 5V signals (for example, potentiometers and tachometers)
- Digital tachometers and resolvers
- Dash display cabling
- RS-232 cabling

Note: Signal inputs to analog and digital blocks should be run as shielded twisted-pair (for example, inputs from tachometers, potentiometers, and dash displays).

4.2.2.b High-Level Signals (Level H)

High-level signals are designated as *level H*. These signals consist of:

- Analog and digital signals greater than 15 V DC and less than 250 mA

For example, switch inputs connected to battery volts are examples of level H signals used in drive equipment cabling.

4.2.2.c Medium-Power Signals (Level MP)

Medium power signals are designated as *level MP*. These signals consist of:

- DC switching signals greater than 15 V
- Signals with currents greater than 250 mA and less than 10A

The following are specific examples of level MP signals used in drive equipment cabling:

- DC busses less than 10 A
- Contactor coils less than 10 A
- Machine fields less than 10 A

4.2.2.d High Power Signals (Level HP)

Power wiring is designated as *level HP*. This consists of DC busses and motor wiring with currents greater than 10 A.

The following are specific examples of level HP signals used in drive equipment cabling:

- Motor armature loops
- DC outputs 10 A and above
- Motor field loops 10 A and above

4.2.3 Cable Spacing Guidelines

Recommended spacing (or clearance) between cables (or wires) is dependent on the level of the wiring inside them. For correct level separation when installing cable, the customer must apply the **general guidelines** (section 4.2.3.a), outlined below.

4.2.3.a General Cable Spacing

The following general practices should be used for *all levels* of cabling:

- All cables and wires of like signal levels and power levels must be grouped together.
- In general, different levels must run in separate wire bundles, as defined in the different classes, identified above. Intermixing cannot be allowed, unless noted by exception.
- Interconnecting wire runs should carry a level designation.
- If wires are the same level and same type signal, group those wires from one location to any other location together in multi-conductor cables or bind them together with twine or zip-ties.
- When unlike signals must cross, cross them in 90° angles at a maximum spacing. Where it is not possible to maintain spacing, place a grounded steel barrier between unlike levels at the crossover point.

4.2.4 Cabling for Vehicle Retrofits

Reducing electrical noise on vehicle retrofits requires careful planning. Lower and higher levels should never encircle each other or run parallel for long distances.

It is practical to use existing wire runs or trays as long as the level spacing (see section 4.2.2) can be maintained for the full length of the run.

Existing cables are generally of high voltage potential and noise producing. Therefore, route levels L and H in a path separate from existing cables, whenever possible. For level L wiring, use barriers in existing wire runs to minimize noise potential. Do not loop level L signal wires around level H, level MP, or HP wires.

4.2.5 RF Interference

To prevent radio frequency (RF) interference, care should be taken in routing power cables in the vicinity of radio-controlled devices.

Section 4.2.6 Suppression

Unless specifically noted otherwise, suppression (for example, a snubber) is required on all inductive devices controlled by an output. This suppression minimizes noise and prevents damage caused by electrical surges.

Section 4.3 Recommended Lubrication of Pins and Sockets Prior to Installation

Beginning in January of 1999, Flight Systems will implement the addition of a lubricant to all connections using pins and sockets on EV100/EV200 and Gen II products. Any connection made by Flight Systems to the A, B, X, Y, or Z plugs will have the lubricant NYE 760G added to prevent fretting of these connections during vehicle operation.

Fretting occurs during microscopic movement at the contact points of the connection. This movement exposes the base metal of the connector pin which, when oxygen is present, allows oxidation to occur. Sufficient build up of the oxidation can cause intermittent contact and intermittent vehicle operation. This can occur at any similar type of connection, whether at the control or in any associated vehicle wiring, and the resultant intermittent contact can provide the same fault indication as actual component failure.

The addition of the NYE 760G lubricant will prevent the oxidation process by eliminating the access of oxygen to the contact point. Flight Systems recommends the addition of this lubricant to the 12 pin and 23 pin plugs of all new Gen II controls at the time of their installation into a vehicle

When servicing existing vehicles exhibiting symptoms of intermittent mis-operation or shutdown by the Flight Systems control, Flight Systems recommends the addition of this lubricant to all 12 and 23 pin plugs, after proper cleaning of the connectors, as a preventative measure to insure fretting is not an issue before Flight Systems control replacement. Also, for long term reliable control operation, the plug terminals must be maintained per these instructions with the recommended contact cleaner and lubricant which provides a high degree of environmental and fretting protection.

New and re-manufactured control plugs are cleaned and lubricated prior to shipment from the factory. However, in applications where severe vibration or high temperature cycling and excessive humidity (such as freezers) are present, it is recommended that the plug terminals be cleaned and lubricated every year, per these instructions. In normal applications, plug maintenance should be performed every two years, unless intermittent problems arise with the plugs, requiring more immediate attention. **Warning: Do not use any other cleaners or lubricants other than the ones specified.**

WARNING: Before conducting maintenance on the vehicle, jack up the drive wheels, disconnect the battery and discharge the capacitors. Consult the Operation and Service Manual for your particular vehicle for details on discharging the capacitors; this procedure differs between SCR and Transistor controls.

1. **Disconnect** plug from controller or mating plug.
2. **Locate** the plug that contains the socket (female) terminals. *Maintenance needs only to be performed on the plug containing the socket (female) type terminals. Reconnecting the plugs will lubricate the pin (male) terminals.*
3. **Clean** each terminal using Chemtronics® contact cleaner "Pow-R-Wash CZ" as shown in Figure 1.

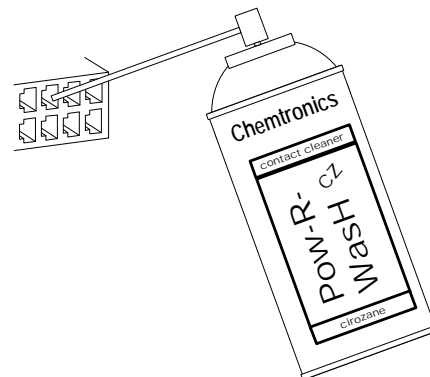

Figure 1

4. **Lubricate** each terminal using Nye® 760G lubricant as shown in figure 2. Apply enough lubricant to each terminal opening to completely fill each opening to a depth of .125" maximum.

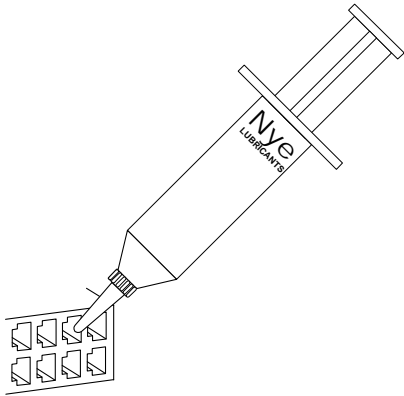

Figure 2

5. **Reconnect** plugs.

Reference

Cleaner	Chemtronics® Pow-R-Wash CZ Contact Cleaner
Lubricant	Nye® Lubricants NYOGEL® 760G
Flight Systems Plug Lub Kit	Contains both above products: 328A1777G1

Section 4.4 Controller Mounting Guidelines

In the design of the Flight Systems family of motor controls, performance assumptions were made based on heat transfer between the control and the ambient environment. The vehicle mounting surface acts as a heat sink, which increases the effective surface area for heat dissipation. If this assumed heat transfer is not achieved during control installation and operation, Flight Systems controllers will fall short of their anticipated performance. It should be noted that the condition of the mounting surface, and the quality of the resulting interface between the control and the vehicle, can significantly hinder heat transfer from the control. The presence of contaminants, or of air voids created by surface inconsistencies in either the vehicle or the control, degrade the control's capacity for heat transfer. The control's performance is degraded proportionally as its own thermal sensors reduce its operation to protect it from damage due to excessive heating.

Contained within the software of the Flight Systems controls are several diagnostic status codes related to controller thermal performance. Failure to follow these mounting recommendations increases the likelihood of encountering these status codes, through no fault of the control itself, thus voiding controller warranty for units returned solely due to the presence

presence of these status codes.

Careful surface preparation, including adequate application of thermal compound, as detailed in the following paragraphs, must be completed during the installation of Flight Systems controls. There are many techniques for applying thermal compound, and we have outlined one approach below that has shown to apply a consistent thickness of material.

Section 4.4.1 Necessary Tools

Flight Systems recommends the use of the following components, or equivalent substitutions, during the control installation process:

- a) Thermal compound, (Dow Corning #340), maintained per the manufacturer's recommendations and free of contaminants
- b) 3/32" notched trowel, such as a Krusin adhesive spreader, model 00031
- c) Calibrated torque wrench (0 – 15 ft-lbs)

Section 4.4.2 The Flight Systems Control Mounting Surface

During the manufacture of the Flight Systems control, the surface flatness is maintained at 0.005" per linear inch (not to exceed 0.025" per 10.0 inches). The surface finish of the Flight Systems control has an R_a (average roughness) of 64 (microinches), or better. This finish is consistent with cold rolled or extruded aluminum.

Care should always be taken in the handling and storage of controllers. The base of the control should be free from nicks, bumps, protrusions or any other foreign object that would prevent the control from sitting flush with the vehicle mounting surface. Examine the base of the control to verify that it is in good condition and free from damage or contamination.

Section 4.4.3 Vehicle Mounting Surface

The quality of the vehicle mounting surface is critical for the optimum heat transfer between the control and the ambient environment. Conduction through the base of the control is the control's only means of heat rejection. While Flight Systems controls are highly efficient, a few percent of the electrical energy will be converted into heat. As previously mentioned, if this energy is not dissipated through the base of the control, a thermal protector will reduce the performance of the control until the temperature stabilizes.

For optimal heat transfer from control to vehicle, the flatness of the vehicle mounting surface should be

equivalent to the flatness of the control surface (0.005" per linear inch). Use a straight edge or dial indicator to verify the mounting surface.

The biggest hindrance to heat transfer is the presence of rust, scale, weld splatter or paint on the vehicle mounting surface. If any of these items are noted, prepare the surface per the following guidelines:

- Clean the mounting surface with a rotary wire brush until the metal surface is exposed.
- Using 80-100 grit emery paper, sand the surface until the metal shines.
- Flush the surface clean with an appropriate liquid de-greaser or parts cleaner.

Section 4.4.4 Application of Thermal Compound

Due to the minute differences in the control mounting surface and the vehicle mounting surface, small pockets of air will be created. These air pockets will add to the overall thermal resistance of the interface.

To avoid these air pockets and improve thermal conductivity, thermal compound must be applied between the Flight Systems control base plate and the vehicle mounting surface. The function of this compound is to conform to surface discrepancies, filling gaps and optimizing the metal-to-metal contact of the control and the vehicle.

- Prepare the two mounting surfaces (control and vehicle) as indicated above.
- Using a triangular notched trowel of 3/32" (.09" +/- .01), apply the grease to the vehicle mounting surface.
- Use straight, non-crossing strokes of the trowel to apply the compound.
- Make multiple vertical passes until a uniform consistency is achieved.



Krusin adhesive spreader model 00031



Vehicle surface after proper grease application

Section 4.4.5 Mounting the Flight Systems Control

- Place the control unit with desired orientation on mounting plate with mounting holes aligned.
- Move the control slightly in all directions to eliminate voids and enhance the distribution of the thermal compound.
- Insert all of the mounting hardware (4, 6 or 8 bolts, M6 or M8, necessary for the mounting of the respective family of controls).
- Tighten these bolts (as per sequence shown in diagrams below) to half of the nominal torque value (**7.5 lb-ft**).
- Lastly, tighten the bolts to the nominal torque value (**15 lb-ft**), following the same sequence.



Calibrated torque wrench for hardware installation

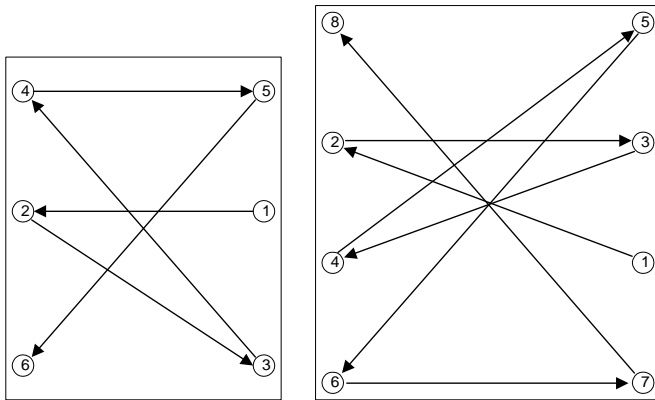
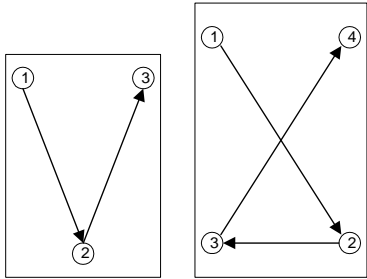

Proper sequence for use in tightening hardware during control mounting

Section 4.4.6 Maintenance

If it is necessary to remove the control for service, careful consideration must be given to removing the old thermal compound from the control and mounting surface, prior to replacement of the unit. **Never** reuse thermal compound. Use a putty knife or similar straight edge to carefully remove all thermal compound residues without damaging either mounting surface. Flush the surfaces with a liquid degreaser or parts cleaner and allow them to dry, before re-applying the thermal compound and mounting the control. Take care not to contaminate the surfaces with hydraulic fluid or battery acid.

Section 4.5 General Troubleshooting Instructions

Trouble-shooting the SX family of controls should be quick and easy when following the instructions outlined in the following status code instruction sheets.

If mis-operation of the vehicle occurs, a status code will be displayed on the Dash Display (for vehicles equipped with a Dash Display) or made available by plugging a Handset into the plug "Y" location, and then reading the status code.

Section 4.6 Traction Control Codes

Note: Status code numbers from 00 to 99 are traction control status codes. Status codes with the prefix 1 (101 to 199) are pump control status codes.

With the status code number, follow the procedures outlined in the status code instruction sheets to determine the problem.

Important Note: Due to the interaction of the logic card with all vehicle functions, almost any status code or control fault could be caused by the logic card. After all other status code procedures have been followed and no problem is found, the controller should then be replaced as the last option to correct the problem.

The same device designations have been maintained on different controls but the wire numbers may vary. Refer to the elementary and wiring diagrams for your specific control. The wire numbers shown on the elementary diagram will have identical numbers on the corresponding wiring diagrams for a specific vehicle, but these numbers may be different from the numbers referenced in this publication.

WARNING: Before trouble-shooting, jack up the drive wheels, disconnect the battery and discharge the capacitors. Reconnect the battery as needed for specific checks. Capacitors should be discharged by connecting a 200 ohm 2 watt resistor between the positive and negative terminals on the control panel.

Check resistance on R x 1000 scale from frame to power and control terminals. A resistance of less than 20,000 ohms can cause misleading symptoms. Resistance less than 1000 ohms should be corrected first.

Before proceeding, visually check for loose wiring, misaligned linkage to the accelerator switch, signs of overheating of components, etc.

Tools and test equipment required are: clip leads, volt-ohm meter (20,000 ohms per volt) and basic hand tools.

TRACTION STATUS CODE	DESCRIPTION OF STATUS	CAUSE OF STATUS INDICATION
2	Drive High or Drive Low mode selected before key switch is closed.	This status code will be displayed when P4 or P6 voltage is greater than P2 voltage.
MEMORY RECALL NO	CORRECTIVE ACTIONS	TROUBLE-SHOOTING DIAGRAM
Circuits valid for Traction Controller	<p>SYMPTOM Control will not operate</p> <p>POSSIBLE CAUSE P4 or P6 voltage is greater than P2 voltage.</p> <ul style="list-style-type: none"> Return Drive Mode selector switch to the Neutral position. Drive Mode selector switch is malfunctioning 	

TRACTION STATUS CODE	DESCRIPTION OF STATUS	CAUSE OF STATUS INDICATION
3	Reverse mode selected before key switch is closed.	This status code will be displayed when P5 voltage is greater than P2 voltage.
MEMORY RECALL NO	CORRECTIVE ACTIONS	TROUBLE-SHOOTING DIAGRAM
Circuits valid for Traction Controller	<p>SYMPTOM Control will not operate</p> <p>POSSIBLE CAUSE P5 voltage is greater than P2 voltage.</p> <ul style="list-style-type: none"> Return Drive Mode selector switch to the Neutral position. Drive Mode selector switch is malfunctioning 	

TRACTION STATUS CODE	DESCRIPTION OF STATUS	CAUSE OF STATUS INDICATION
4	Emergency brake switch is open.	This status code will be displayed when P13 is greater than 2.5 volts.
MEMORY RECALL NO	CORRECTIVE ACTIONS	TROUBLE-SHOOTING DIAGRAM
Circuits valid for Traction Controller	<p>SYMPTOM Control will not operate; buzzer will sound.</p> <p>POSSIBLE CAUSE Emergency brake switch input mis-adjusted or defective.</p> <ul style="list-style-type: none"> Input voltage at P13 should be less than 2.5VDC. Adjust or replace the brake switch to insure that the voltage at P13 is less than 2.5VDC. <p>Open circuit between battery negative and P13 in the emergency brake switch input circuit.</p> <ul style="list-style-type: none"> Disconnect wire from P13. Check for open circuit between this wire and battery negative. <p>Defective controller.</p> <ul style="list-style-type: none"> Voltage measured between P13 and negative should be 4.5VDC. If not, replace control. 	

TRACTION STATUS CODE	DESCRIPTION OF STATUS	CAUSE OF STATUS INDICATION
5	Start switch fails to close.	This status code will be displayed when the accelerator voltage at P7 is >1.4V, with the start switch open (P3 > 2.5 volts)
MEMORY RECALL NO	CORRECTIVE ACTIONS	TROUBLE-SHOOTING DIAGRAM
Circuits valid for Traction Controller	<p>SYMPTOM Control will not operate.</p> <p>POSSIBLE CAUSE Defective start switch circuit.</p> <ul style="list-style-type: none"> Check start switch to insure closure when accelerator pedal is depressed. Check for open circuit or loose connections in start switch wiring. Check for proper accelerator pot adjustment <p>Defective accelerator switch.</p> <ul style="list-style-type: none"> Check accelerator switch potentiometer for proper operation and ohmic value 	

TRACTION STATUS CODE	DESCRIPTION OF STATUS	CAUSE OF STATUS INDICATION
6	The accelerator pedal is depressed with no direction selected.	This status code will be displayed when the accelerator voltage, at P7 > 1.4V, and no direction is selected (P4 and P5 are both less than 50% of battery volts)
MEMORY RECALL NO	CORRECTIVE ACTIONS	TROUBLE-SHOOTING DIAGRAM
Circuits valid for Traction Controller	<p>SYMPTOM Control will not operate.</p> <p>POSSIBLE CAUSE Accelerator pedal is depressed before closing forward or reverse directional switch.</p> <ul style="list-style-type: none"> Status code will disappear when directional switch is closed or when accelerator pedal is released. <p>Defective directional switch</p> <ul style="list-style-type: none"> Check forward or reverse switch to insure closure when direction is selected. <p>Open circuit between directional switch(es) and battery positive or between directional switch(es) and P4 or P5.</p> <ul style="list-style-type: none"> Check all control wires and connections shown in trouble shooting diagram. 	

TRACTION STATUS CODE	DESCRIPTION OF STATUS	CAUSE OF STATUS INDICATION
8	Accelerator voltage input is too high on power up after initial key switch closure.	This status code will be displayed when the accelerator input voltage at P7 > 0.9V when the battery plug or key switch is opened and closed.
MEMORY RECALL NO	CORRECTIVE ACTIONS	TROUBLE-SHOOTING DIAGRAM
Circuits valid for Traction Controller	<p>SYMPTOM Control will not operate</p> <p>POSSIBLE CAUSE Accelerator input is misadjusted or defective.</p> <ul style="list-style-type: none"> Input voltage at P7 should be less than 0.9 volts. Adjust or replace accelerator unit to insure that the voltage at P7 is less than 0.9 volts before depressing pedal. <p>Open circuit at P8 or open potentiometer wiper at P7 – verify continuity of wiring at both points.</p>	

TRACTION STATUS CODE	DESCRIPTION OF STATUS	CAUSE OF STATUS INDICATION
9	Both the forward and reverse switches or the turf and reverse switches are closed at the same time.	This status code will be displayed when P4 and P5 or P6 and P5 are greater than 50% of battery volts.
MEMORY RECALL NO	CORRECTIVE ACTIONS	TROUBLE-SHOOTING DIAGRAM
Circuits valid for Traction Controller	<p>SYMPTOM Control will not operate.</p> <p>POSSIBLE CAUSE Forward or reverse or turf switch welded closed or misadjusted to be held closed.</p> <ul style="list-style-type: none"> Replace or adjust directional switches to insure that they are open when switch is returned to neutral or off. <p>Short circuit between battery positive and P4,P5 and/or P6.</p> <ul style="list-style-type: none"> Disconnect wires from P4, P6 and P5 and check wire for short circuit to positive side of directional switch <p>Defective control.</p> <ul style="list-style-type: none"> Disconnect wires and measure voltage at P4, P6 and P5. Voltage should be less than 50% of battery volts, if not, replace control. 	

TRACTION STATUS CODE	DESCRIPTION OF STATUS	CAUSE OF STATUS INDICATION
11	Start switch closed on power up after initial key switch closure.	This status code will be displayed when P3 is less than 2.5 volts when the key switch is closed.
MEMORY RECALL NO	CORRECTIVE ACTIONS	TROUBLE-SHOOTING DIAGRAM
Circuits valid for Traction Controller	<p>SYMPTOM Control will not operate.</p> <p>POSSIBLE CAUSE Start switch is misadjusted or defective.</p> <ul style="list-style-type: none"> Input voltage at P3 should be greater than 2.5 volts at key switch closure. Adjust or replace accelerator unit to insure that the voltage at P3 greater than 2.5 volts before closing the start switch. <p>Short circuit between battery negative and P3 in start switch input circuit.</p> <ul style="list-style-type: none"> Disconnect wire from P3. Check for short circuit from this wire to battery negative. Resistance should be greater than 20K ohms. <p>Defective control.</p> <ul style="list-style-type: none"> Disconnect wire from P3. Measure voltage from P3 to negative. Voltage should be 2.5 to 5.0 volts. If not, replace the control. 	

TRACTION STATUS CODE	DESCRIPTION OF STATUS	CAUSE OF STATUS INDICATION
14	Rolling Radius or Gear Ratio or Top Speed parameters are out of limits for the motor.	This status code will be displayed when the Rolling Radius or Gear Ratio or Top Speed perimeters are out of limits for the motor.
MEMORY RECALL NO	CORRECTIVE ACTIONS	TRUBLE-SHOOTING DIAGRAM NO GRAPHIC FOR THIS STATUS CODE
Circuits valid for Traction Controller	<p>SYMPTOM Control will not operate.</p> <p>POSSIBLE CAUSE Functions 13, 16 or 21 are programmed to an incorrect value.</p> <p>Reprogram the above functions to the proper value and the status code should clear.</p>	

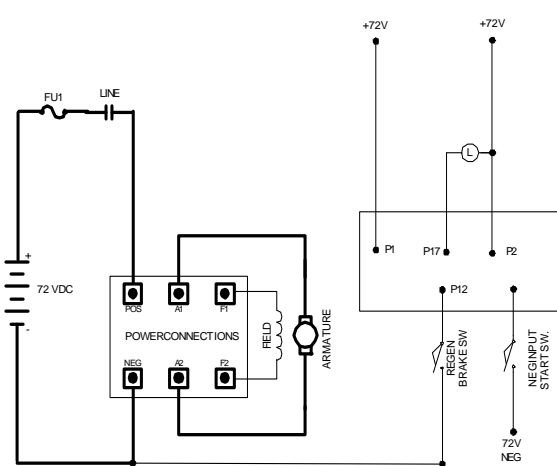
TRACTION STATUS CODE	DESCRIPTION OF STATUS	CAUSE OF STATUS INDICATION
15	Battery voltage is too low at initial key switch closure.	This status code will be displayed when the battery volts are less than 68.3 volts at initial key switch on.
MEMORY RECALL NO	CORRECTIVE ACTIONS	TRUBLE-SHOOTING DIAGRAM 
Circuits valid for Traction Controller	<p>SYMPTOM Control will not operate.</p> <p>POSSIBLE CAUSE Discharged battery</p> <ul style="list-style-type: none"> Check battery voltage to confirm that it is a minimum of 68.3 volts. Charge battery, if required. <p>Defective battery</p> <ul style="list-style-type: none"> Check each battery cell for proper voltage (greater than 1.95 volts at cell). Replace or repair battery. <p>Incorrect control card adjustment.</p> <ul style="list-style-type: none"> Check Function 15 for proper adjustment for battery being used. See Handset instruction sheet for details. Adjust to proper settings. <p>Check "minimum" battery volts at P1 & NEG.</p>	

TRACTION STATUS CODE	DESCRIPTION OF STATUS	CAUSE OF STATUS INDICATION
16	Battery voltage is too high at initial key switch closure.	This status code will be displayed when the battery volts are greater than 86 volts at initial key switch on.
MEMORY RECALL NO	CORRECTIVE ACTIONS	<u>TROUBLE-SHOOTING DIAGRAM</u>
Circuits valid for Traction Controller	<p><u>SYMPTOM</u> Control will not operate.</p> <p><u>POSSIBLE CAUSE</u> Discharged battery</p> <ul style="list-style-type: none"> • Check battery voltage to confirm that it is a minimum of 68.3 volts. Charge battery, if required. <p>Battery overcharged or incorrect battery used.</p> <ul style="list-style-type: none"> • Check each battery cell for proper voltage (maximum 2.4 volts per cell). If voltage is excessive, check battery charger for proper output voltage. <p>Incorrect control card adjustment.</p> <ul style="list-style-type: none"> • Check Function 15 for proper adjustment for battery being used. See Handset instruction sheet for details. Adjust to proper settings. <p>Check "maximum" battery volts at P1 & NEG.</p>	

TRACTION STATUS CODE	DESCRIPTION OF STATUS	CAUSE OF STATUS INDICATION
21	Accelerator voltage is too high.	This status code will be displayed when the accelerator voltage at P7 is greater than 4.5 volts.
MEMORY RECALL NO	CORRECTIVE ACTIONS	<u>TROUBLE-SHOOTING DIAGRAM</u>
Circuits valid for Traction Controller	<p><u>SYMPTOM</u> Control will not operate.</p> <p><u>POSSIBLE CAUSE</u> Accelerator input is misadjusted or defective.</p> <ul style="list-style-type: none"> Input voltage at P7 should be less than 4.5 volts after initial key switch closure. Open wire exists between potentiometer negative and P8. Open wire exists between P7 and potentiometer wiper. 	<p>The diagram shows a terminal block with terminals P1 through P17. P1, P17, P2, P21, P6, P4, P5, and P10 are connected to +72V. P12 is connected to 72V NEG. P3 is connected to a REGEN BRAKE SW. P13 is connected to a NEG INPUT START SW. P13 is also connected to a NEG INPUT BRAKE SW. P22 is connected to RS232. P9, P7, and P8 are connected to an ACC POT. P15, P14, and P16 are connected to a TACHOMETER (RED, GREEN, BLACK). P6 is connected to MOTOR OVER TEMP. P4 is connected to TURF SW. P5 is connected to FORWARD SW. P5 is also connected to REVERSE SW. P10 is connected to a BUZZER.</p>

TRACTION STATUS CODE	DESCRIPTION OF STATUS	CAUSE OF STATUS INDICATION
23	Motor field current is too high when the key switch is turned on.	This status code will be displayed when the current draw in the motor field is too high on start up.
MEMORY RECALL NO	CORRECTIVE ACTIONS	<u>TROUBLE-SHOOTING DIAGRAM</u>
Circuits valid for Traction Controller	<p><u>SYMPTOM</u> Control will not operate.</p> <p><u>POSSIBLE CAUSE</u> Defective control.</p> <ul style="list-style-type: none"> Replace controller unit. 	<p>NO GRAPHIC FOR THIS STATUS CODE</p>

TRACTION STATUS CODE	DESCRIPTION OF STATUS	CAUSE OF STATUS INDICATION
24	Motor field current is too high when the key switch is turned on.	This status code will be displayed when the current draw in the motor field is too high on start up.
MEMORY RECALL NO	CORRECTIVE ACTIONS	<u>TROUBLE-SHOOTING DIAGRAM</u>
Circuits valid for Traction Controller	<p><u>SYMPTOM</u> Control will not operate.</p> <p><u>POSSIBLE CAUSE</u> Defective control.</p> <ul style="list-style-type: none"> Replace controller unit. 	NO GRAPHIC FOR THIS STATUS CODE

TRACTION STATUS CODE	DESCRIPTION OF STATUS	CAUSE OF STATUS INDICATION
27	12V buss is too low.	This status code will be displayed when the internal power supply of the control dips below 9.35V.
MEMORY RECALL YES	CORRECTIVE ACTIONS	<u>TROUBLE-SHOOTING DIAGRAM</u>
Circuits valid for Traction Controller	<p><u>SYMPTOM</u> Line contactor opens and closes and then can only be closed by opening and closing the key switch.</p> <p><u>POSSIBLE CAUSE</u> Discharged battery.</p> <ul style="list-style-type: none"> Check battery to insure proper state of charge. Voltage may be dropping below 15V under load. <p>Loose connection at P1.</p> <ul style="list-style-type: none"> Insure that the wire connection at P1 is tight. <p>Shorted Motor Tachometer</p> <ul style="list-style-type: none"> Disconnect tach and run control, if status code 27 does not appear, check tach. <p>Defective control.</p> <ul style="list-style-type: none"> Replace controller unit. 	<p>The diagram illustrates the power and control circuits for the motor. On the left, a 72VDC battery is connected to a fuse (FU1) and a line input. The power then flows through a line contactor (L) to the motor's field and armature. The control circuit on the right shows a +72V supply connected to a line contactor (L) and a 72V NEG terminal. The 72V NEG terminal is connected to a regen brake switch and a negative input start switch. The motor's field and armature are connected to the power connections (POS, NEG, X1, X2, P1, P2).</p>

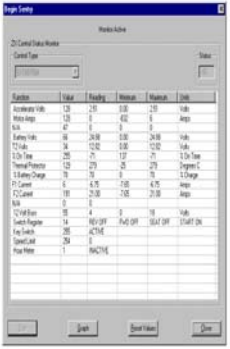
TRACTION STATUS CODE	DESCRIPTION OF STATUS	CAUSE OF STATUS INDICATION
41	Shorted thermal protector (TP) or transistor over temperature.	This status code will be displayed when the voltage at the thermal protector is too low.
MEMORY RECALL YES	CORRECTIVE ACTIONS	<u>TROUBLE-SHOOTING DIAGRAM</u>
Circuits valid for Traction Controller	<p>SYMPTOM Reduced or no power to traction motor in control range.</p> <p>POSSIBLE CAUSE Control is in thermal cut back.</p> <ul style="list-style-type: none"> Allow control to cool, status code should disappear. <p>Defective control.</p> <ul style="list-style-type: none"> Replace controller unit. (Values of less than 1.5 V at the thermal protector are typically indicative of a failed control.) <p><i>GE Sentry for Windows</i> software can be used to monitor control operation, and it will display a value for the thermal protector that is greater than 84 (corresponding to 1.65V), triggering this status code.</p>	

TRACTION STATUS CODE	DESCRIPTION OF STATUS	CAUSE OF STATUS INDICATION
42	Motor armature offset voltage is too high.	This status code will be displayed when the value of motor amps is greater than 133 (corresponding to 2.7 volts) with no current flowing in the motor circuit.
MEMORY RECALL NO	CORRECTIVE ACTIONS	<u>TROUBLE-SHOOTING DIAGRAM</u>
Circuits valid for Traction Controller	<p>SYMPTOM Control will not operate.</p> <p>POSSIBLE CAUSE Defective control.</p> <ul style="list-style-type: none"> Replace controller unit. <p><i>GE Sentry for Windows</i> software can be used to monitor control operation, and it will display a value for the motor amps that is greater than 133, (corresponding to 2.6V), triggering this status code.</p>	

TRACTION STATUS CODE	DESCRIPTION OF STATUS	CAUSE OF STATUS INDICATION
43	Motor armature offset voltage is too low.	This status code will be displayed when the value of motor amps is less than 123 (corresponding to 2.4 volts) with no current flowing in the motor circuit.
MEMORY RECALL NO	CORRECTIVE ACTIONS	<u>TROUBLE-SHOOTING DIAGRAM</u>
Circuits valid for Traction Controller	<p><u>SYMPTOM</u> Control will not operate.</p> <p><u>POSSIBLE CAUSE</u> Defective control.</p> <ul style="list-style-type: none"> Replace controller unit. <p><i>GE Sentry for Windows software can be used to monitor control operation, and it will display a value for the motor amps that is less than 123 (corresponding to 2.4V), triggering this status code.</i></p>	

TRACTION STATUS CODE	DESCRIPTION OF STATUS	CAUSE OF STATUS INDICATION
44	Armature transistor did not turn off properly.	This status code will be displayed when, during control operation, the armature transistor fails to turn off. This will result in a PMT condition
MEMORY RECALL YES	CORRECTIVE ACTIONS	<u>TROUBLE-SHOOTING DIAGRAM</u>
Circuits valid for Traction Controller	<p><u>SYMPTOM</u> Line contactor opens and closes, then can only be closed by opening and closing the key switch.</p> <p><u>POSSIBLE CAUSE</u> Defective control.</p> <ul style="list-style-type: none"> Replace controller unit. 	NO GRAPHIC FOR THIS STATUS CODE

TRACTION STATUS CODE	DESCRIPTION OF STATUS	CAUSE OF STATUS INDICATION
45	Armature transistor did not turn on properly.	This status code will be displayed when, during control operation, the armature transistor fails to turn on properly. This will result in a PMT condition
MEMORY RECALL YES	CORRECTIVE ACTIONS	<u>TROUBLE-SHOOTING DIAGRAM</u>
Circuits valid for Traction Controller	<p><u>SYMPTOM</u> Control will not operate.</p> <p><u>POSSIBLE CAUSE</u> Defective control.</p> <ul style="list-style-type: none"> Replace controller unit. 	NO GRAPHIC FOR THIS STATUS CODE

TRACTION STATUS CODE	DESCRIPTION OF STATUS	CAUSE OF STATUS INDICATION
46	“Look Ahead” test for A2 volts is less than 12.5% of battery volts.	This status code will be displayed when the voltage at A2 is less than 12.5% of battery volts and I_m is greater than 52 amps, when the control is in the neutral state, with no start switch selected.
MEMORY RECALL YES	CORRECTIVE ACTIONS	<u>TROUBLE-SHOOTING DIAGRAM</u>
Circuits valid for Traction Controller	<p><u>SYMPTOM</u> Line contactor will not pickup.</p> <p><u>POSSIBLE CAUSE</u> Check for short circuit from the motor armature to the frame of the vehicle.</p> <p>Defective control.</p> <ul style="list-style-type: none"> Replace controller unit. 	<p>The diagram illustrates the electrical circuit for the traction controller. It shows a battery (BATT) connected to a positive terminal (POS) and a negative terminal (NEG). A 400A fuse (FU1) is connected between POS and the A1 terminal of the control unit. A 10A fuse (FU3) is connected between POS and the LINE terminal. The control unit has terminals POS, NEG, A1, and A2. The A1 terminal is connected to the F1 terminal of the armature circuit, and the A2 terminal is connected to the F2 terminal. The armature circuit includes a relay (REL) and the armature itself.</p>

TRACTION STATUS CODE	DESCRIPTION OF STATUS	CAUSE OF STATUS INDICATION
49	Motor field current is too low during the run mode.	This status code will be displayed when the current draw in the motor field is less than 1.3 amps and armature current is greater than 100 amps for more than 1.27 seconds during the run mode.
MEMORY RECALL YES	CORRECTIVE ACTIONS	<u>TROUBLE-SHOOTING DIAGRAM</u>
Circuits valid for Traction Controller	<p><u>SYMPTOM</u> Control will not operate.</p> <p><u>POSSIBLE CAUSE</u> Motor field is open circuit</p> <ul style="list-style-type: none"> • Replace motor <p>Loose between control and motor field</p> <ul style="list-style-type: none"> • Check connections <p>Defective control.</p> <ul style="list-style-type: none"> • Replace controller unit. 	NO GRAPHIC FOR THIS STATUS CODE

TRACTION STATUS CODE	DESCRIPTION OF STATUS	CAUSE OF STATUS INDICATION
51	Capacitor volts are low before the line contactor closes.	This status code will be displayed during "key on" when the capacitor volts is less than 85% of battery volts at initial key switch on.
MEMORY RECALL NO	CORRECTIVE ACTIONS	<u>TROUBLE-SHOOTING DIAGRAM</u>
Circuits valid for Traction Controller	<p><u>SYMPTOM</u> Line contactor does not close when capacitor does not pre-charge.</p> <p><u>POSSIBLE CAUSE</u> Defective control fuse.</p> <ul style="list-style-type: none"> • Check control fuse for open circuit condition. Replace fuse, if necessary. • Turn key off and wait 1 minute, then try again. <p>Defective control.</p> <ul style="list-style-type: none"> • Replace controller unit. 	<p>The diagram shows a battery (BATT) connected to a 400A fuse (FU1) and a 10A fuse (FU3). The circuit passes through a line contactor (LINE) to a control unit. The control unit has terminals POS, NEG, A1, and A2. The motor field is connected between F1 and F2, and the armature is connected between A1 and A2.</p>

TRACTION STATUS CODE	DESCRIPTION OF STATUS	CAUSE OF STATUS INDICATION
57	Controller "motor current sensor" input is too low during running.	This status code will be displayed when the voltage input from the current sensor is too low (less than 1.0V, 416 amps) during running.
MEMORY RECALL YES	CORRECTIVE ACTIONS	<u>TROUBLE-SHOOTING DIAGRAM</u>
Circuits valid for Traction Controller	<p>SYMPTOM Control will not operate.</p> <p>POSSIBLE CAUSE Line contactor tips bounce or are not fully picked up.</p> <p>Blown power fuse.</p> <p>Loose power connections between battery and control.</p> <p>Defective control.</p> <ul style="list-style-type: none"> Replace controller unit. 	NO GRAPHIC FOR THIS STATUS CODE

TRACTION STATUS CODE	DESCRIPTION OF STATUS	CAUSE OF STATUS INDICATION
64	The line driver input (P2-17) is less than 12% of battery volts	This status code will be displayed when the control detects that the line driver input (P2-17) is less than 12% battery volts when the key switch is turned on.
MEMORY RECALL NO	CORRECTIVE ACTIONS	<u>TROUBLE-SHOOTING DIAGRAM</u>
Circuits valid for Traction Controller	<p>SYMPTOM Control will not operate.</p> <p>POSSIBLE CAUSE Open wire connection to Pin 17 on control</p> <p>Shorted line driver transistor</p> <p>Open line contactor coil</p> <p>Open connection between line contactor coil and battery positive.</p> <p>Defective control.</p>	<p>The diagram shows a pin header with pins P1 through P16. Connections include: P1 (+72V), P17 (+72V), P2 (+72V), P21 (+72V), P6 (+72V), P4 (+72V), P5 (+72V), P10 (+72V) connected to a BUZZER; P12 (72V NEG) connected to a REGEN BRAKE SW; P3 (72V NEG) connected to a NEG INPUT START SW; P13 (72V NEG) connected to a NEG INPUT BRAKE SW; P22 connected to RS232; P9 connected to an ACC POT; P7 and P8 connected to a TACHOMETER (RED, GREEN, BLACK); P21 connected to a MOTOR OVER TEMP sensor; P6 connected to a TURF SW; P4 connected to a FORWARD SW; P5 connected to a REVERSE SW.</p>

TRACTION STATUS CODE	DESCRIPTION OF STATUS	CAUSE OF STATUS INDICATION
65	The line coil current is too high during the run mode	This status code will be displayed when the current limit in the line coil is exceeded during the run mode. The line contactor will drop out and the key switch will have to be recycled to reset the control.
MEMORY RECALL YES	CORRECTIVE ACTIONS	<u>TROUBLE-SHOOTING DIAGRAM</u>
Circuits valid for Traction Controller	<p><u>SYMPTOM</u> Control will not operate.</p> <p><u>POSSIBLE CAUSE</u></p> <p>Shorted line contactor coil</p> <p>Short between wires connected to line coil (wires #10 and 24)</p> <p>Insure that all inductive loads are suppressed.</p> <p>Incorrect line contactor coil.</p> <p>Defective control.</p> <ul style="list-style-type: none"> Replace controller unit. 	

TRACTION STATUS CODE	DESCRIPTION OF STATUS	CAUSE OF STATUS INDICATION
66	The field current exceeds the current limit of the field transistor.	This status code will be displayed when the field transistor exceeds its current limit. The line contactor will drop out and the key switch will have to be recycled to restart the control.
MEMORY RECALL YES	CORRECTIVE ACTIONS	TROUBLE-SHOOTING DIAGRAM
Circuits valid for Traction Controller	<p>SYMPTOM Control will not operate or is sluggish on start up. Line contactor opens.</p> <p>POSSIBLE CAUSES</p> <ul style="list-style-type: none"> • Shorted field F1 to F2 • F1 or F2 terminals shorted to battery positive (B+) • Confirm that all inductive loads/accessories are suppressed. • Motor armature or field shorted to frame. <p>Defective control.</p> <ul style="list-style-type: none"> • Replace controller unit. 	

TRACTION STATUS CODE	DESCRIPTION OF STATUS	CAUSE OF STATUS INDICATION
76	Capacitor (1C) voltage too high during pedal up regen braking.	This status code will be displayed when the voltage at 1C exceeds 96 volts during the regenerative braking cycle.
MEMORY RECALL YES	CORRECTIVE ACTIONS	TROUBLE-SHOOTING DIAGRAM
Circuits valid for Traction Controller	<p>SYMPTOM Line contactor opens and closes, then opens and can only close by opening and closing the key switch.</p> <p>POSSIBLE CAUSE Batteries are overcharged.</p> <ul style="list-style-type: none"> • Regen current too high, cycle key switch off then on. <p>Defective control.</p> <ul style="list-style-type: none"> • Replace controller unit. 	

TRACTION STATUS CODE	DESCRIPTION OF STATUS	CAUSE OF STATUS INDICATION
77	Capacitor (1C) voltage too high during motoring.	This status code will be displayed when the voltage at 1C exceeds 96 volts during motoring.
MEMORY RECALL YES	CORRECTIVE ACTIONS	<u>TROUBLE-SHOOTING DIAGRAM</u>
Circuits valid for Traction Controller	<p><u>SYMPTOM</u> Line contactor opens and closes, then opens and can only close by opening and closing the key switch.</p> <p><u>POSSIBLE CAUSE</u></p> <p>Regen current too high, cycle key switch off then on.</p> <p>Defective control.</p> <ul style="list-style-type: none"> Replace controller unit. 	

TRACTION STATUS CODE	DESCRIPTION OF STATUS	CAUSE OF STATUS INDICATION
81	No tachometer signal is detected.	This status code will be displayed when no tachometer signal is detected.
MEMORY RECALL YES	CORRECTIVE ACTIONS	<u>TROUBLE-SHOOTING DIAGRAM</u>
Circuits valid for Traction Controller	<p><u>SYMPTOM</u> Vehicle's speed will limited to about half of the normal speed.</p> <p><u>POSSIBLE CAUSE</u> Defective tachometer.</p> <ul style="list-style-type: none"> Replace tachometer unit <p>Defective wiring between tachometer and the control.</p> <ul style="list-style-type: none"> Check and repair wiring as required. <p>Stalled motor</p> <ul style="list-style-type: none"> Cycle key switch off then on. 	<p>The diagram shows a central connector with pins P1 through P17, P21, P6, P4, P5, P10, P12, P3, P13, P22, P23, P20, P9, P7, P8, P15, P14, and P16. Various components are connected to these pins: P1 (+72V), P17 (Lamp), P2 (+72V), P21 (MOTOR OVER TEMP), P6 (TURF SW), P4 (FORWARD SW), P5 (REVERSE SW), P10 (BUZZER), P12 (72V NEG), P3 (REGEN BRAKE SW), P13 (NEG INPUT START SW), P22 (NEG INPUT BRAKE SW), P23 (RS232), P20 (ACC POT), P9 (TACHOMETER RED), P7 (TACHOMETER GREEN), P8 (TACHOMETER BLACK), P15 (TACHOMETER RED), P14 (TACHOMETER GREEN), P16 (TACHOMETER BLACK).</p>

TRACTION STATUS CODE	DESCRIPTION OF STATUS	CAUSE OF STATUS INDICATION
82	If the armature current greater than 280 amps for longer than 3.5 seconds in control mode, the armature motoring current will be turned off.	This status code will be displayed when the armature current exceeds 280 amps for 3.5 sec and the accelerator pedal is calling for maximum performance in the control mode.
MEMORY RECALL NO	CORRECTIVE ACTIONS	TROUBLE-SHOOTING DIAGRAM
Circuits valid for Traction Controller	<p>SYMPTOM The Control will not operate, and can only be reset by cycling the key switch.</p> <p>POSSIBLE CAUSE:</p> <ul style="list-style-type: none"> Continued operation of vehicle in high motor current condition Operating control at stall motor current for more than 3.5 seconds. Defective motor tachometer Function 16 is incorrectly adjusted for control % on time. <p>Adjust function per OEM instructions</p>	

TRACTION STATUS CODE	DESCRIPTION OF STATUS	CAUSE OF STATUS INDICATION
90	If the motor thermal switch opens, the controller will reduce the amount of current to motor as defined by Function 1. This status code is only available on controllers with TT1J and later firmware.	This status code will be displayed when the voltage at P21 is below 12% of battery volts (Example...below 9.6V for an 80V system).
MEMORY RECALL YES	CORRECTIVE ACTIONS	TROUBLE-SHOOTING DIAGRAM
Circuits valid for Traction Controller	<p>SYMPTOM The Control will continue to operate in current limit as defined by Function 1..</p> <p>POSSIBLE CAUSE:</p> <ul style="list-style-type: none"> Motor is overheated causing the thermal switch to open. Defective motor thermal switch Defective control. <p>Adjust function per OEM instructions</p>	

**Section 5. SX and IT FAMILY Flight Systems
HANDSET INSTRUCTIONS**

Section 5.1 General Features

The Flight Systems Handset is a multi-functional tool to be used with the LX, ZX, SX and IT Series Flight Systems solid-state controls. The Handset consists of a Light Emitting Diode (LED) display and a keyboard for data entry.

Note: The Handset is the same for all Flight Systems controls, however, the cable will change between some control types.

Section 5.2 Purpose / Setup Functions

The purpose of the Handset is to allow authorized personnel to perform the following functions of the SX and IT/IP family of Controls:

- Monitor existing system fault codes
- Monitor intermittent random fault codes
- Monitor battery state of charge on systems with BDI
- Monitor hourmeter reading
- Monitor or adjust the following control functions:
 - ◆ Creep speed
 - ◆ Armature Controlled Acceleration and 1A Time
 - ◆ Regenerative Braking Current Limit and Disable
 - ◆ Armature and Field Current Limit
 - ◆ Plugging Distance (Current)
 - ◆ Pedal Position Plug Range or Disable
 - ◆ 1A Drop Out Current or Disable
 - ◆ Speed Limit Points
 - ◆ Truck Management Fault Speed Limit
 - ◆ Internal Resistance Compensation for Battery State of Charge Indication
 - ◆ Battery Voltage (36/48 volts is auto ranging)
 - ◆ Selection of Card Operation Type.

Warning: Before connecting or disconnecting the Handset tool, turn off the key switch, unplug the battery and jack up the drive wheels of the vehicle.

At the transistor control traction card, unplug the "Y plug" if the dash display is in use, and plug in the Handset to the plug location "Y" on the control card. After installing the Handset tool, plug the battery in and turn the key switch on. The following is the start-up display sequence that will occur:

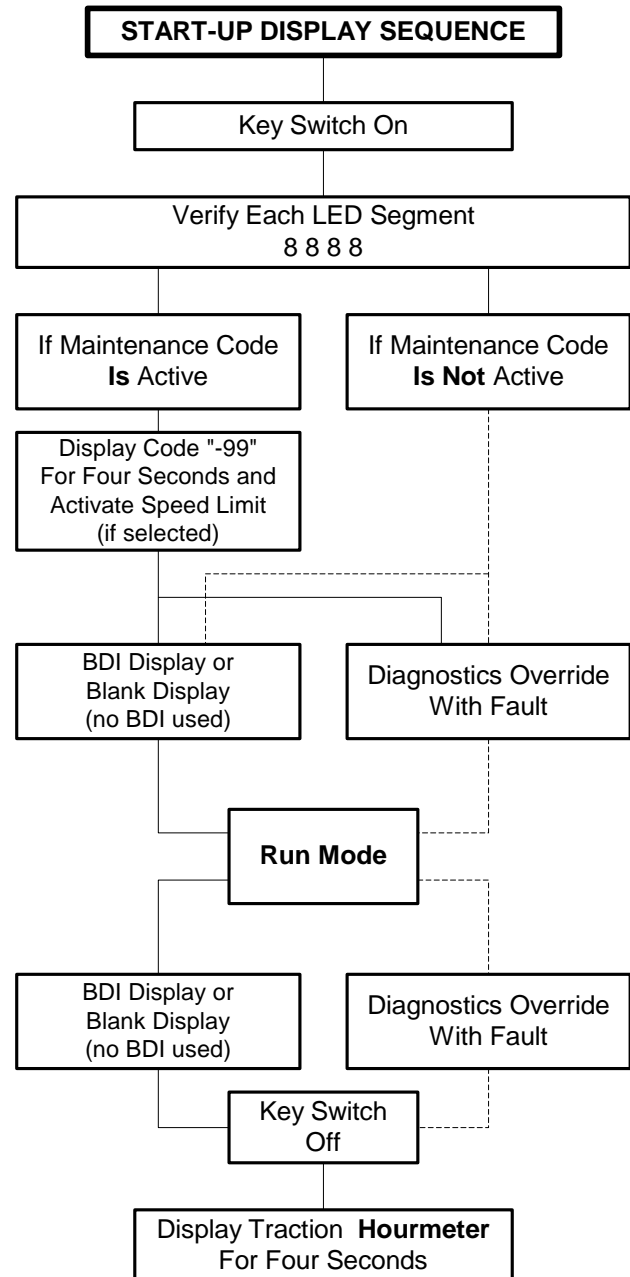

NOTE: The vehicle can be operated with the Handset connected, however, the adjustment knob must be set fully clockwise to insure the control operates at top speed.

Warning: Before making any adjustments to the control, you must consult the operating and maintenance instructions supplied by the vehicle manufacturer. Failure to follow proper set up instructions could result in mis-operation or damage to the control system.

Section 5.3 Set-up Function Procedures

With the Handset connected, hold down the **CONT** key and turn on the key switch. This will place you in the set-up mode, ready to monitor or adjust control function settings.

NOTE: The term “Push” means to depress key for approximately one second.

Section 5.3.1 Setup Mode

SET-UP MODE		
ACTION	DISPLAY SHOWS	REMARKS
Hold Down CONT And Turn On Key	8 8 8 8	Segment Check Displayed
Push Function Number	U 0 0 5	Selected Function No. Is Displayed
After One Second Time Delay	0 8 5	Stored Value For The Function Is Displayed
Push CONT	0 8 5	Display Value Will Blink
Change Value With Adjustment Knob	1 2 5	Value Changes While Blinking
Push STORE	1 2 5	New Value Stored And Blinking Stops
Push ESC	8 8 8 8	Segment Check Displayed

At this point, another function can be monitored/changed by pushing another function number, or the vehicle can be placed in the run mode by holding the **ESC** key down for one second or longer. The display will return to either the diagnostics mode, the BDI display, or a blank display (if BDI is not used and there are no fault codes). The vehicle can now be operated with the Handset connected, or the Handset can be disconnected before operation.

NOTE: You can return to the segment check mode at any time, by holding down the **ESC** key until 8888 appears in the display.

Section 5.3.2 Status Code Scrolling

The SX and IT families of controllers furnish a function register that contains the last 16 “stored status codes” that shut down vehicle operation (a PMT type fault that is reset by cycling the key switch) and the battery state of charge reading at the time the fault occurred. The first of the 16

the 16 status codes will be overwritten each time a new status code occurs. This stored status code register can be cleared from memory by using the Handset.

ACCESSING STORED STATUS CODES WITH GE HANDSET

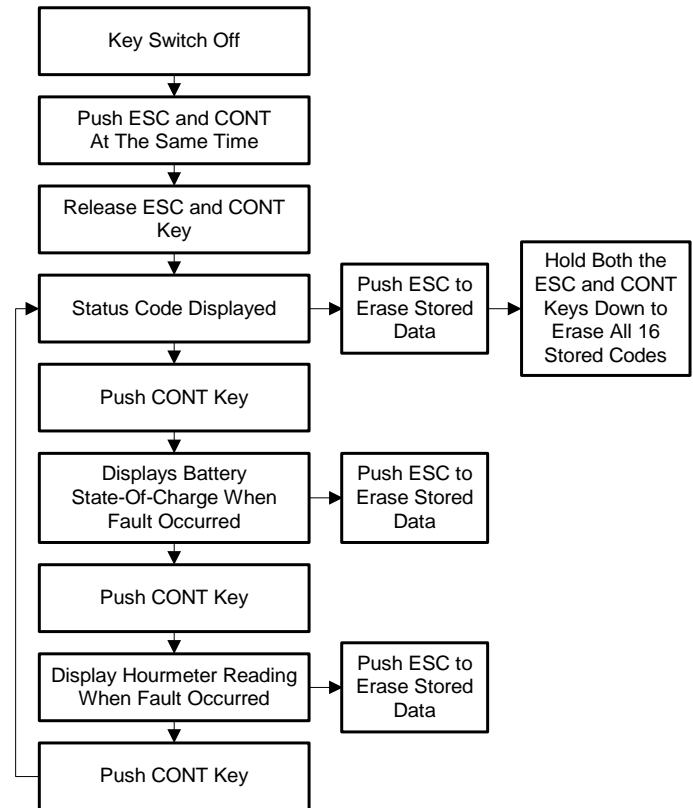

Section 5.3.3 IT Family Handset, Plug Connections and Outline Drawing

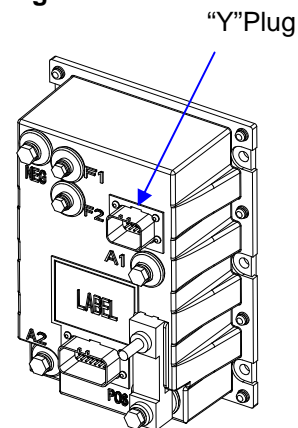

Handset Cable Part Number - 171B3990G4

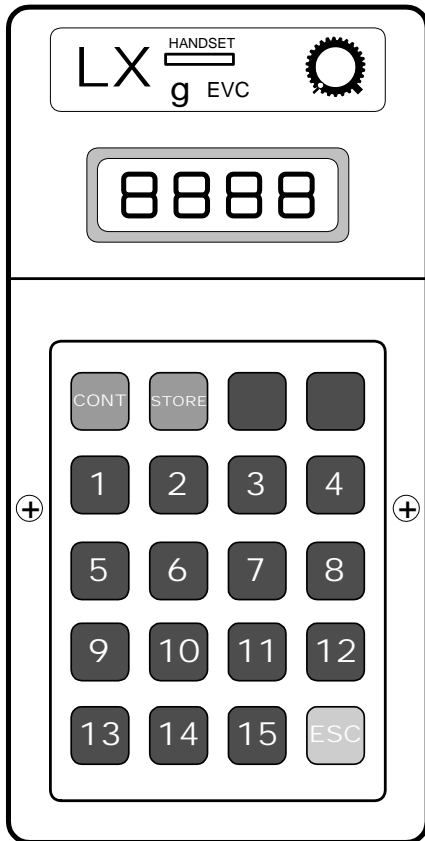

Section 5.4 Setup Functions for Traction Controller

FUNCTION 1 ARMATURE CURRENT LIMIT DURING MOTOR OVERTEMP (Push 1)

This function represents the armature current level regulated when the motor thermal switch has opened.

Setting: 0 to 255
Resolution: 1.5A per set unit
Example: (Setting Value of 100 x 1.5) = 150 Amps

NOTE: This function is only available on TT1J revision firmware and later.

FUNCTION 2 CREEP SPEED (Push 2)

This function allows for the adjustment of the creep speed of the vehicle. Creep speed can be adjusted when an accelerator input voltage between 3.9 and 3.3 volts or an accelerator ohm input between 6.0K and 4.0K ohms is provided.

Range 2% to 15% on-time
Set 0 to 255
Resolution 0.05% per set unit
Example Setting of 20 = 3% on-time

Important Note: This function is used to optimize motor and control performance, and this setting will be determined by Flight Systems and OEM engineers at the time of vehicle development. This setting must not be changed by field personnel without the permission of the OEM.

FUNCTION 3 ARMATURE ACCELERATION (Push 3) CONTROLLED

This function allows for the adjustment of the rate of time it takes for the control to accelerate to 100% applied battery voltage to the motor on hard acceleration.

Range 0.1 to 25.5 seconds
Set 0 to 255
Resolution 0.086 seconds per set unit
Example: Setting of 20 = 1.72 seconds

FUNCTION 4 ARMATURE CURRENT LIMIT (Push 4)

This function allows for the adjustment of the armature current limit of the control. The rating of the control will determine the range of adjustment for this function. Please refer to the specification sheets and current limit curves for the control used in your vehicle.

Range See control C/L curves
Set 0 to 255
Example: 0 = min. current, 255 = max. current

FUNCTION 5 ARMATURE / BRAKING CURRENT (Push 5)

This function represents the braking current level regulated with the accelerator pedal switch closed or the vehicle speed is greater than the speed limit.

Setting: 0 to 255
Resolution: 1.5A per set unit
Example: (Setting Value x 1.5) = Amps

FUNCTION 6 Accelerator Input Slope Select (Push 6)

This function is used to select the accelerator input slope.

Setting	Input Voltage Range	Response
20 to 29	0.5 to 3.0 VDC	Linear
30 to 39	0.5 to 3.0 VCD	Non-Linear

Linear = 50% travel equal 50% on time
Non-Linear = 50% travel equals 25% on time

FUNCTION 7 MIN FIELD CURRENT
(Push 7)

This function allows the adjustment of the field weakening level in order to set the top speed of the motor.

Min	Max	Set	Resolution Per Unit Value
0	50	51 to 255	0.269

MIN $I_F = (VAL-51) \times 0.269$

Important Note: This function is used to optimize motor and control performance, and this setting will be determined by Flight Systems and OEM engineers at the time of vehicle development. This setting must not be changed by field personnel without the permission of the OEM.

FUNCTION 8 MAX FIELD CURRENT
(Push 8)

This function allows for the adjustment of the maximum field current in order to obtain the maximum torque of the motor.

Min	Max	Set	Resolution Per Unit Value
0	50	51 to 255	0.269

MAX $I_F = (VAL-51) \times 0.269$

Important Note: This function is used to optimize motor and control performance, and this setting will be determined by Flight Systems and OEM engineers at the time of vehicle development. This setting must not be changed by field personnel without the permission of the OEM.

FUNCTION 9 REGEN BRAKING C/L
(Push 9)

This function allows for the adjustment of the Regen braking current limit. Higher current correlates to shorter stopping distance.

Min	Max	Set	Resolution Per unit value	Example If set at 53
32A	382A	0 to 255	1.5 amps	80 amps

REGEN BRAKE $I_A = (VAL \times 1.5)$

FUNCTION 10 REGEN FIELD CURRENT LIMIT
(Push 10)

This function allows for the adjustment of the field current to be used during the regen braking mode.

Resolution	Example

Min	Max	Set	Per unit value	If set at 71
0	50	51 to 255	0.269 amps	5.38 amps

$I_F = (VAL-51) \times 0.269$

Important Note: This function is used to optimize motor and control performance and this setting will be determined by Flight Systems and OEM engineers at the time of vehicle development. This setting must not be changed by field personnel without the permission of the OEM.

FUNCTION 11 TURF SPEED LIMIT
(Push 11)

This function allows for the adjustment of the top speed of the vehicle (maximum battery volts to the motor) when it is being operated in the forward direction.

Range	0 to 255
Set	0 to 255
Resolution	0.25MPH per set unit
Example:	Setting of 60 x 0.25 = 15mph

FUNCTION 12 REVERSE SPEED LIMIT
(Push 12)

This function allows for the adjustment of the top speed of the vehicle (maximum battery volts to the motor) when it is being operated in the reverse direction.

Range	0 to 255
Set	0 to 255
Resolution	0.25mph per set unit
Example:	Setting of 50 x 0.25 = 12.5mph

FUNCTION 13 ROLLING RADIUS
(Push 13)

This function adjusts for tire rolling radius.

Range	0 to 255
Resolution	0.1
Example	RR = 11.4in / 0.1 = 114
Set Value	114

FUNCTION 14 INTERNAL COMPENSATION
(Push 14)

This function is used when the Battery Discharge Indicator is present. Adjustment of this function will improve the accuracy of the BDI. In order to determine this setting the voltage drop of the battery under load must first be calculated by the following method:

1. Load the traction motor to 100 amps at 100% on-time of the control and record the open circuit voltage (V_O) at the control panel positive and negative power terminal.
2. Load the traction motor to 200 amps at 100% on time of the control and record the voltage (V_L) at the control panel positive and negative power terminal.
3. Calculate voltage drop (V_{Drop}) as follows:
$$V_{Drop} = V_O - V_L$$
4. Use the table below to determine the appropriate setting using the calculated V_{Drop} as a reference.

INTERNAL RESISTANCE COMPENSATION TABLE

Setting	V_{Drop}	Setting	V_{Drop}
2	11.44	17	01.34
3	07.60	18	01.27
4	05.72	19	01.20
5	04.57	20	01.14
6	03.81	21	01.09
7	03.27	22	01.04
8	02.86	23	00.99
9	02.54	24	00.95
10	02.28	25	00.91
11	02.08	26	00.88
12	01.90	27	00.85
13	01.76	28	00.82
14	01.63	29	00.79
15	01.52	30	00.76
16	01.43	31	00.74

FUNCTION 15 BATTERY VOLTS (Push I5)

This function allows for the adjustment of voltage range for controls equipped with the Battery Discharge Indication function. In order for the BDI to operate properly, the setting as shown in the table must be entered:

Battery volts	Set units
24 volts	Between 0 and 31
36 volts	Between 32 and 44
48 volts	Between 45 and 69
72 volts	Between 70 and 80
80 volts	Between 81 and 183
36/48 volts	Between 184 and 250
No BDI	Between 251 and 255

FUNCTION 16 GEAR RATIO (Push CONT 1)

This function allows for the adjustment of transmission gear ratio.

Range	0 to 255
Setting	0 to 255
Resolution	0.1
Example	GR = 12.4 / 0.1 = 124
Set Value	124

FUNCTION 17 FIELD GAIN (Push CONT 2)

This function allows for the adjustment of the pedal up field gain. This value is determined by Flight Systems application engineering and should be set using the OEM setting specifications for this vehicle.

FUNCTION 18 LINE CONTACTOR COIL VOLTAGE (Push CONT 4)

this function sets the voltage level at which the line contactor and brake coils are held.

Range	0 to 96 volts
Setting	0 to 255
Resolution	0.377 volts per set unit

$$\text{Voltage} = \text{SETTING VALUE} / 2.65$$

FUNCTION 19 PEDAL DOWN/BRAKE REGEN RATE (Push CONT 4)

This function allows for the adjustment of the rate at which speed is reduced during regenerative braking under speed regulation.

Range	0.1 to 25.5 seconds
Set	0 to 255
Resolution	0.086 seconds per set unit
Example:	Setting of 20 = 1.72 seconds

Setting of 1 = Most aggressive braking
Setting of 255 = Least aggressive braking

FUNCTION 20 PEDAL UP REGEN RATE (Push CONT 5)

This function adjusts the rate at which speed is reduced during regenerative braking when the accelerator pedal is released and start switch opens or the control receives a directional change signal.

Setting	1 to 255
Setting of 1	= Most aggressive braking
Setting of 255	= Least aggressive braking

FUNCTION 21 TOP SPEED REGULATION
(Push CONT 6)

This function adjusts the top speed regulation point of the vehicle.

Range 0 to 63.75mph
 Setting 0 to 255
 Resolution 0.25mph per set unit
 Example Setting of 100 x 0.25 = 25mph

FUNCTION 22 OVERSPEED DECREASE RATE FOR FIELD/ARMATURE CURRENT
(Push CONT 7)

This function adjusts the rate at which the armature and field currents decrease when the accelerator pedal is released with the start switch closed, or when the vehicle speed is less than the speed limit.

Setting 1 to 255
 Setting of 1 = Most aggressive braking
 Setting of 255 = Least aggressive braking

FUNCTION 23 NOT USED

FUNCTION 24 FIELD WEAKENING START
(Push CONT 9)

This function allows for setting the armature current at which minimum field current will be achieved .

Range 0 to 414 Amps
 Setting 0 to 255
 Resolution 1.625 per set unit

$I_{MOTOR} FWS = VAL. \times 1.625$
 Example: Setting of 20 = 32.5 amps

The following functions have function numbers larger than the numbers on the Handset keyboard. To access these functions. Push the CONT key and the number shown in the following instructions at the same time. THE SEAT SWITCH MUST BE CLOSED.

FUNCTION 25 MONITOR
(Push CONT 10)

This function allows the monitoring of certain control functions by looking directly at the RAM of the microprocessor. Because absolute memory locations need to be known, this function should not be used without detailed instructions from the Flight Systems application engineer.

This function should only be adjusted by the vehicle OEM. To ensure optimum operation of the control, this function must be left with zero stored in this register.

FUNCTION 26 BASE RATIO
(Push CONT 11)

This function sets the ratio between armature and field current when operating below the maximum field current and above the Field Weakening Start point. The setting represents the quantity of field current changed for each 1 amp of armature current changed.

Max Ratio	Setting	Resolution Per Value
0.329 Amps/Amp	0 to 255	0.00129

Range 0 to 0.329 Amps/Amp
 Setting 0 to 255
 Resolution 0.00129 per unit value
 Example: Setting of 100 = 0.129 Amps/Amp

For the example above, this means that for every amp the armature increases above the Field Weakening Start point the field current will increase by 0.129 amps

FUNCTION 28 STORED STATUS CODE COUNT POINTER
(Push CONT 13)

This register contains the location of the last stored status code recorded of the 16 stored status codes. These stored status codes have caused a PMT controller shutdown and/or disruption of normal vehicle operation.

To determine which stored status code was the last one recorded, read the number stored in Function 28. Using the **Memory Map** for your logic card, match the "**stored status code pointer number**" [the number shown in (***bold italics***) in the HS (Handset) number column] on the memory map, with the number obtained from Function 28. This will be the last stored status code recorded.

Note: **When scrolling through the stored status code register, the register always starts at status code 1 and scrolls to status code 16. Instructions for scrolling the register are in section 5.3.2 of this instruction booklet.**

Section 5.5 Summary of Current Limit

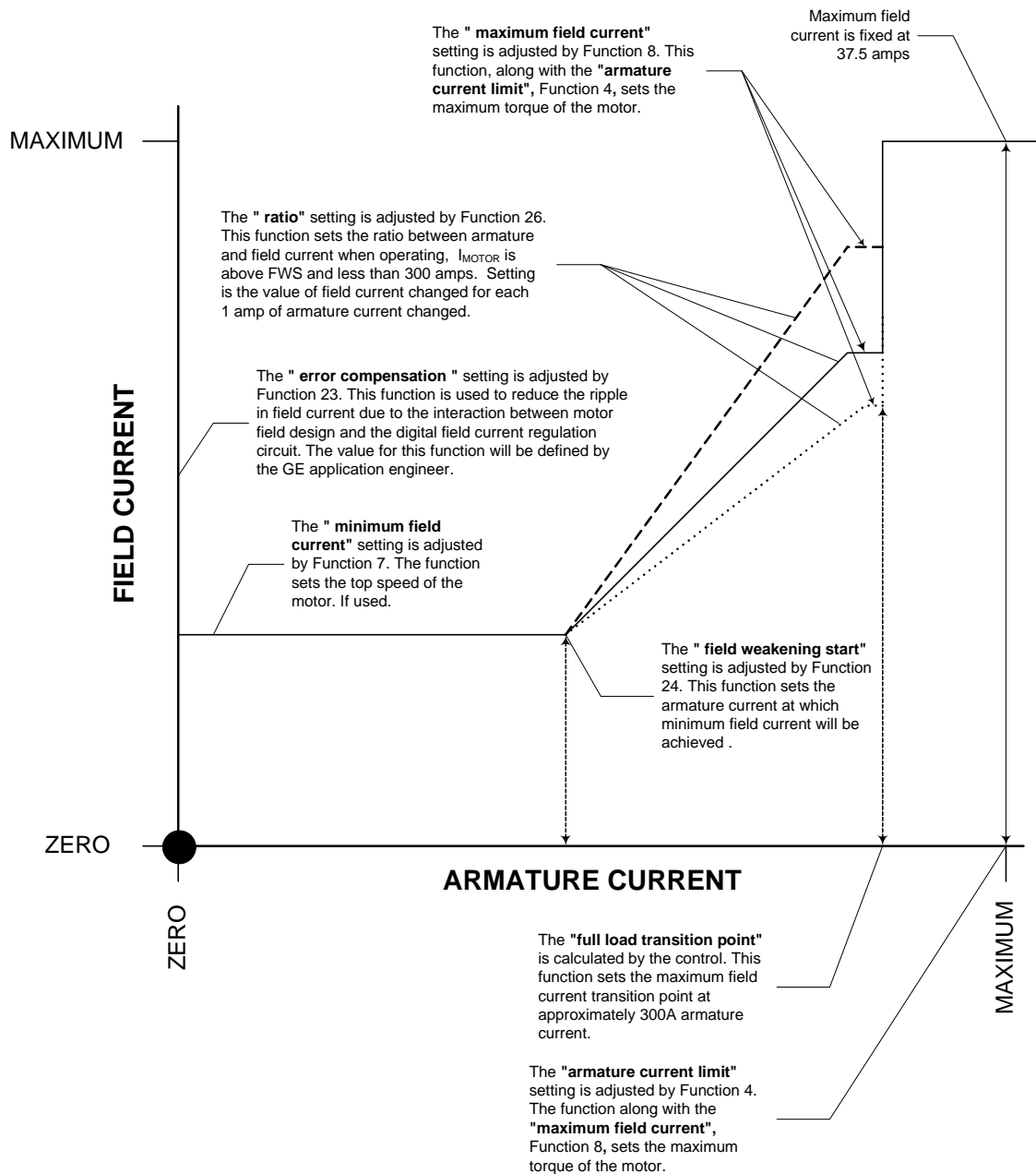

Adjustments

Section 6.0 MEMORY MAP

E²	Func No.	Traction Control Function	Access By	Restrictions
0	1	Armature Current Limit During Motor Overtemp	PC or PDA	None
1	2	Creep Speed	PC or PDA	None
2	3	Armature Acceleration Rate	PC or PDA	None
3	4	Max Armature Current Limit	PC or PDA	None
4	5	Armature Braking Rate	PC or PDA	None
5	6	Accelerator Slope Select	PC or PDA	None
6	7	Min Field Current	PC or PDA	None
7	8	Max Field Current	PC or PDA	None
8	9	Regen Braking Current Limit	PC or PDA	None
9	10	Regen Field Current Limit	PC or PDA	None
10	11	Turf Speed Limit	PC or PDA	None
11	12	Reverse Speed Limit	PC or PDA	None
12	13	Rolling Radius in Inches	PC or PDA	None
13	14	Internal Resistance Compensation	PC or PDA	None
14	15	Battery Volts Select	PC or PDA	None
15	16	Gear Ratio in Tenths	PC or PDA	None
16	17	Pedal Down Field Rate Gain	PC or PDA	None
17	18	Line Contactor Coil Voltage	PC or PDA	None
18	19	Pedal Down Regen Decel Rate	PC or PDA	None
19	20	Pedal Up Regen Decel Rate	PC or PDA	None
20	21	MPH Overspeed	PC or PDA	None
21	22	Overspeed Brake Rate	PC or PDA	None
22	23	NA	PC or PDA	None
23	24	Field Weakening Start	PC or PDA	None
24	25	Monitor	PC or PDA	None
25	26	Base Ratio	PC or PDA	None
26	27	MINUTES	PC or PDA	None
27	28	Stored Status Code Count Pointer	PC or PDA	None
28	29	HR	PC or PDA	None
29	30	HR	PC or PDA	None
30	31	HR	PC or PDA	None
31	32	HR	PC or PDA	None
32	33	Stored Status Code #1	PC or PDA	Reset to Zero Only
33	34	BDI 1	PC or PDA	Reset to Zero Only
34	35	Hours (Tens/Ones) 1	PC or PDA	Reset to Zero Only
35	36	Hours (Thou/Hun) 1	PC or PDA	Reset to Zero Only
36	37	Stored Status Code #2	PC or PDA	Reset to Zero Only
37	38	BDI 2	PC or PDA	Reset to Zero Only
38	39	Hours (Tens/Ones) 2	PC or PDA	Reset to Zero Only
39	40	Hours (Thou/Hun) 2	PC or PDA	Reset to Zero Only
40	41	Stored Status Code #3	PC or PDA	Reset to Zero Only
41	42	BDI 3	PC or PDA	Reset to Zero Only
42	43	Hours (Tens/Ones) 3	PC or PDA	Reset to Zero Only

E²	Func No.	Traction Control Function	Access By	Restrictions
43	44	Hours (Thou/Hun) 2	PC or PDA	Reset to Zero Only
44	45	Stored Status Code #4	PC or PDA	Reset to Zero Only
45	46	BDI 4	PC or PDA	Reset to Zero Only
46	47	Hours (Tens/Ones) 4	PC or PDA	Reset to Zero Only
47	48	Hours (Thou/Hun) 4	PC or PDA	Reset to Zero Only
48	49	Stored Status Code #5	PC or PDA	Reset to Zero Only
49	50	BDI 5	PC or PDA	Reset to Zero Only
50	51	Hours (Tens/Ones) 5	PC or PDA	Reset to Zero Only
51	52	Hours (Thou/Hun) 5	PC or PDA	Reset to Zero Only
52	53	Stored Status Code #6	PC or PDA	Reset to Zero Only
53	54	BDI 6	PC or PDA	Reset to Zero Only
54	55	Hours(Tens/Ones) 6	PC or PDA	Reset to Zero Only
55	56	Hours(Thou/Hun) 6	PC or PDA	Reset to Zero Only
56	57	Stored Status Code #7	PC or PDA	Reset to Zero Only
57	58	BDI 7	PC or PDA	Reset to Zero Only
58	59	Hours(Tens/Ones) 7	PC or PDA	Reset to Zero Only
59	60	Hours(Thou/Hun) 7	PC or PDA	Reset to Zero Only
60	61	Stored Status Code #8	PC or PDA	Reset to Zero Only
61	62	BDI 8	PC or PDA	Reset to Zero Only
62	63	Hours(Tens/Ones) 8	PC or PDA	Reset to Zero Only
63	64	Hours(Thou/Hun) 8	PC or PDA	Reset to Zero Only
64	65	Stored Status Code #9	PC or PDA	Reset to Zero Only
65	66	BDI 9	PC or PDA	Reset to Zero Only
66	67	Hours(Tens/Ones) 9	PC or PDA	Reset to Zero Only
67	68	Hours(Thou/Hun) 9	PC or PDA	Reset to Zero Only
68	69	Stored Status Code #10	PC or PDA	Reset to Zero Only
69	70	BDI 10	PC or PDA	Reset to Zero Only
70	71	Hours(Tens/Ones) 10	PC or PDA	Reset to Zero Only
71	72	Hours(Thou/Hun) 10	PC or PDA	Reset to Zero Only
72	73	Stored Status Code #11	PC or PDA	Reset to Zero Only
73	; 74	BDI 11	PC or PDA	Reset to Zero Only
74	75	Hours(Tens/Ones) 11	PC or PDA	Reset to Zero Only
75	76	Hours(Thou/Hun) 11	PC or PDA	Reset to Zero Only
76	77	Stored Status Code #12	PC or PDA	Reset to Zero Only
77	78	BDI 12	PC or PDA	Reset to Zero Only
78	79	Hours(Tens/Ones) 12	PC or PDA	Reset to Zero Only
79	80	Hours(Thou/Hun) 12	PC or PDA	Reset to Zero Only
80	81	Stored Status Code #13	PC or PDA	Reset to Zero Only
81	82	BDI 13	PC or PDA	Reset to Zero Only
82	83	Hours(Tens/Ones) 13	PC or PDA	Reset to Zero Only
83	84	Hours(Thou/Hun) 13	PC or PDA	Reset to Zero Only
84	85	Stored Status Code # 14	PC or PDA	Reset to Zero Only
85	86	BDI 14	PC or PDA	Reset to Zero Only
86	87	Hours(Tens/Ones) 14	PC or PDA	Reset to Zero Only
87	88	Hours(Thou/Hun) 14	PC or PDA	Reset to Zero Only
88	89	Stored Status Code # 15	PC or PDA	Reset to Zero Only

E²	Func No.	Traction Control Function	Access By	Restrictions
89	90	BDI 15	PC or PDA	Reset to Zero Only
90	91	Hours (Tens/Ones) 15	PC or PDA	Reset to Zero Only
91	92	Hours (Thou/Hun) 15	PC or PDA	Reset to Zero Only
92	93	Stored Status Code #16	PC or PDA	Reset to Zero Only
94	95	Hours (Tens/Ones) 16	PC or PDA	Reset to Zero Only
95	96	Hours (Thou/Hun) 16	PC or PDA	Reset to Zero Only
96	97	N/A	PC or PDA	None
97	98	N/A	PC or PDA	None
98	99	N/A	PC or PDA	None
99	100	N/A	PC or PDA	None
100	101	Spare	PC or PDA	None
101	102	Spare	PC or PDA	None
102	103	Spare	PC or PDA	None
103	104	Spare	PC or PDA	None
104	105	Spare	PC or PDA	None
105	106	Spare	PC or PDA	None
106	107	Spare	PC or PDA	None
107	108	Spare	PC or PDA	None
108	109	Spare	PC or PDA	None
109	110	Spare	PC or PDA	None
110	111	Spare	PC or PDA	None
111	112	Spare	PC or PDA	None
112	113	Secure HM (Tens/Ones)	PC or PDA	OEM Read Only
113	114	Secure HM (Thou/Hun)	PC or PDA	OEM Read Only
114	115	Secure Aux HM (Tens/Ones)	PC or PDA	OEM Read Only
115	116	Secure Aux HM (Thou/Hun)	PC or PDA	OEM Read Only
116	117	Field Offset	PC or PDA	OEM Read Only
117	118	Field Offset	PC or PDA	OEM Read Only
118	119	Armature Offset	PC or PDA	OEM Read Only
119	120	Reserved	PC or PDA	None
120	121	OEM Use	PC or PDA	None
121	122	OEM Use	PC or PDA	None
122	123	OEM Use	PC or PDA	None
123	124	OEM Use	PC or PDA	None
124	125	Mile 1	PC or PDA	None
125	126	Mile 100	PC or PDA	None
126	127	Mile 1A	PC or PDA	None
127	128	Mile 6	PC or PDA	None

Numbers in (***bold italics***) are Stored Status Code pointers.