



**CURTIS**

# Manual

## Models **1204M/05M/09M/21M**

Electronic Motor Controllers  
with Universal Logic Board



**Curtis Instruments, Inc.**  
200 Kisco Avenue  
Mt. Kisco, NY 10549  
[www.curtisinstruments.com](http://www.curtisinstruments.com)



Read Instructions Carefully!

Specifications are subject to change without notice.

© 2012 Curtis Instruments, Inc. © Curtis is a registered trademark of Curtis Instruments, Inc.

© The design and appearance of the products depicted herein are the copyright of Curtis Instruments, Inc.

53121 Rev A 9/12



<b>CONTENTS</b>	
1. OVERVIEW .....	1
2. INSTALLATION AND WIRING .....	3
Mounting the 1204M/05M Controller.....	3
Mounting the 1209M/21M Controller.....	4
Connections: High Current .....	5
Connections: Low Current.....	5
Controller Wiring Configuration, with active main driver .....	7
Controller Wiring Configuration, with active reverse input .....	8
KSI Wiring .....	8
Forward/Reverse Wiring.....	9
Throttle Wiring .....	10
Wiring Configuration for Pump Applications .....	14
Installation Checkout.....	15
3. PROGRAMMABLE PARAMETERS.....	17
Voltage Parameters .....	18
Current Parameters .....	19
Speed Parameters.....	20
Throttle Input Parameters.....	21
Miscellaneous Parameters.....	23
Controller Cloning .....	24
4. MONITOR MENU.....	25
5. DIAGNOSTICS AND TROUBLESHOOTING .....	26
6. MAINTENANCE .....	30
<b>APPENDIX A</b> EMC & ESD Design Considerations	
<b>APPENDIX B</b> Programming Devices	
<b>APPENDIX C</b> Controller Specifications	

## FIGURES

FIG. 1:	Curtis 1204M and 1209M electronic motor controllers.....	1
FIG. 2:	Mounting dimensions, Curtis 1204M/05M controllers .....	3
FIG. 3:	Mounting dimensions, Curtis 1209M/21M controllers.....	4
FIG. 4:	Standard wiring configuration, with active main driver .....	7
FIG. 5:	Standard wiring configuration, with active reverse input .....	8
FIG. 6:	Wiring to inhibit plug braking .....	9
FIG. 7:	Wiring for mechanical reversing .....	10
FIG. 8:	Wiring for Type 0 throttles .....	10
FIG. 9:	Wiring for Type 1, 3, 4, and 5 throttles .....	11
FIG. 10:	Wiring for Type 2 throttles .....	13
FIG. 11:	Wiring configuration for pump applications .....	14
FIG. 12:	Effect of throttle adjustment parameters.....	22

## TABLES

TABLE 1:	High current connections.....	5
TABLE 2:	Low current connections .....	5
TABLE 3:	J4 connector pinout .....	6
TABLE 4:	Status LED fault codes .....	26
TABLE 5:	Troubleshooting chart .....	28

## 1

## OVERVIEW

Curtis 1204M, 1205M, 1209M, and 1221M series motor controllers are the form/fit/function replacements of the earlier 1204/1205/1209B/1221B controllers, with the added functionality of being programmable—via a Curtis handheld programmer or PC programming station. This means the controllers can be tailored to the needs of specific applications. In addition to configuration flexibility, use of the programmer offers diagnostic and test capability.

These controllers are the ideal solution for a variety of electric vehicle applications, including industrial trucks, personnel carriers, material handling vehicles, light on-road vehicles, golf cars, etc.

**Fig. 1** *Curtis 1204M and 1209M programmable series motor controllers.*

*Except for their length, the 1204M and 1205M look the same, as do the 1209M and 1221M.*



Like all Curtis controllers, the 1204M/05M/09M/21M models offer superior operator control of motor drive performance. **Features include:**

- ✓ Universal logic board supports multiple throttle types and high pedal disable (HPD) options.
- ✓ Environmental protection provided by rugged anodized aluminum extruded housing.
- ✓ Simple mounting and wiring with push-on connectors for control signals.
- ✓ Plated solid copper buses used for all power connections.
- ✓ Thermal protection and compensation circuit provides constant current limit over operating range and during under/over temperature cutback; no sudden loss of power under any thermal conditions.
- ✓ Throttle fault protection circuitry disables controller if throttle wires become open.
- ✓ HPD feature prevents controller operation if key is turned on while throttle is applied.

*More Features* 

- ✓ Plug braking diode internal to controller.
- ✓ Undervoltage cutback function protects against low battery voltage, including low voltage caused by external loads.
- ✓ Easily programmable through the Curtis handheld programmer or PC programming station.

Familiarity with your Curtis 1204M/05M/09M/21M controller will help you install and operate it properly. We encourage you to read this manual carefully. If you have questions, please contact the Curtis office nearest you.

## 2

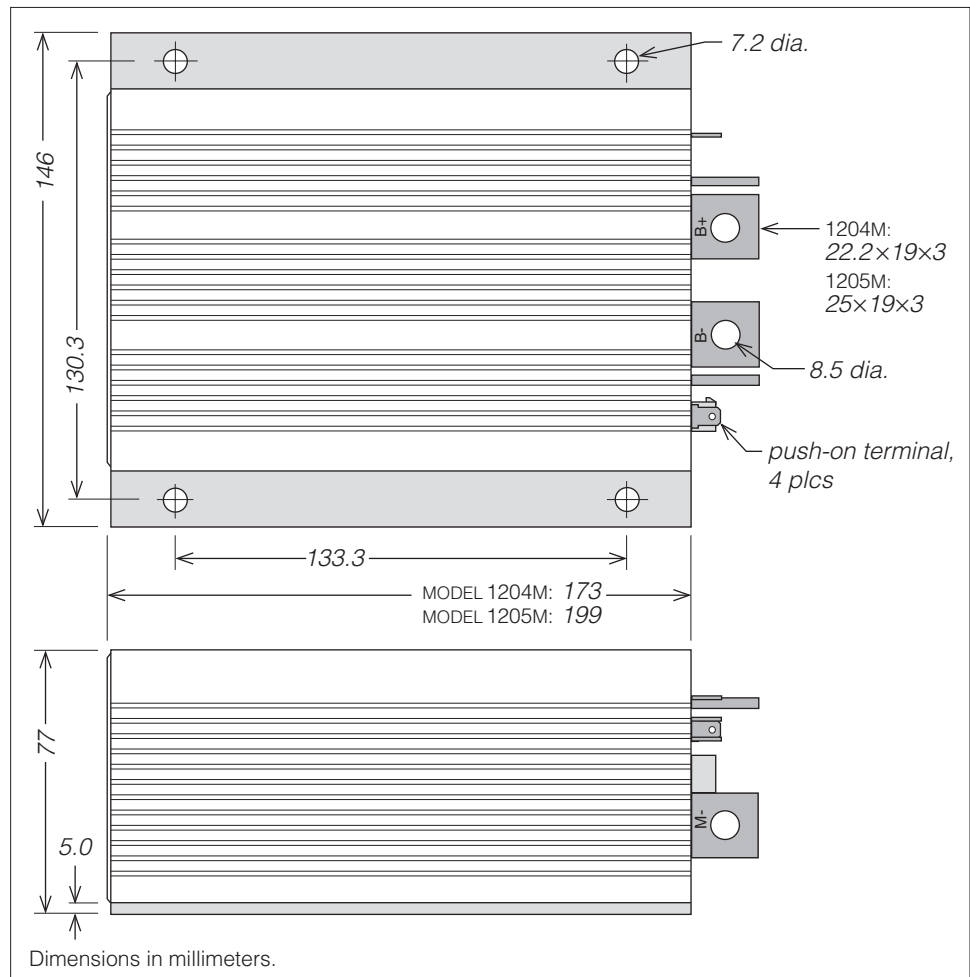
## INSTALLATION AND WIRING

## MOUNTING THE CONTROLLER

The outline and mounting hole dimensions are shown for the 1204M and 1205M controllers in Figure 2, and for the 1209M and 1221M controllers in Figure 3. The controllers meet the IP54 requirements for environmental protection against dust and water. Nevertheless, in order to prevent external corrosion and leakage paths from developing, **the mounting location should be carefully chosen to keep the controller as clean and dry as possible.**

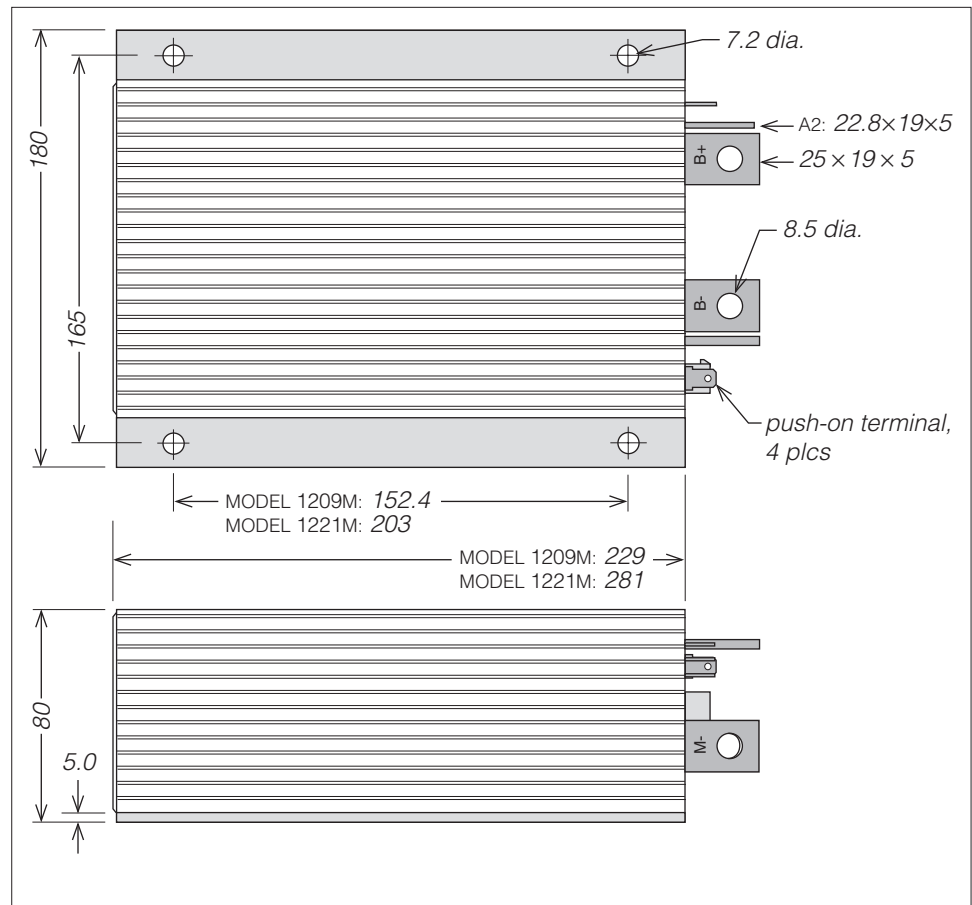
It is recommended that the controller be fastened to a clean, flat metal surface with four M6 bolts, using the holes provided. The mounting surface is an integral part of the overall heatsinking of the controller, and affects its ability to dissipate heat. Although not usually necessary, a thermal joint compound can be used to improve heat conduction from the controller heatsink to the mounting surface.

**Fig. 2** Mounting dimensions, Curtis 1204M and 1205M motor controllers.



You will need to take steps during the design and development of your end product to ensure that its EMC performance complies with applicable regulations; suggestions are presented in Appendix A.

**Fig. 3** Mounting dimensions, Curtis 1209M and 1221M motor controllers.



These controllers contain **ESD-sensitive components**. Use appropriate precautions in connecting, disconnecting, and handling the controller. See installation suggestions in Appendix A for protecting the controller from ESD damage.



**Working on electrical systems is potentially dangerous.** You should protect yourself against uncontrolled operation, high current arcs, and outgassing from lead acid batteries:

**UNCONTROLLED OPERATION** — Some conditions could cause the motor to run out of control. Disconnect the motor or jack up the vehicle and get the drive wheels off the ground before attempting any work on the motor control circuitry.

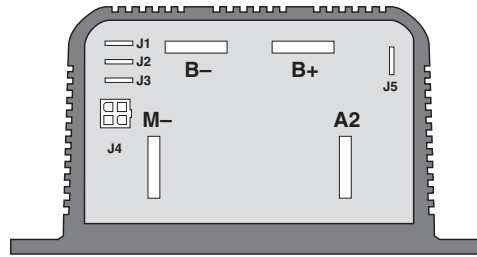
**HIGH CURRENT ARCS** — Batteries can supply very high power, and arcing can occur if they are short circuited. Always open the battery circuit before working on the motor control circuit. Wear safety glasses, and use properly insulated tools to prevent shorts.

**LEAD ACID BATTERIES** — Charging or discharging generates hydrogen gas, which can build up in and around the batteries. Follow the battery manufacturer's safety recommendations. Wear safety glasses.



## CONNECTIONS

The controller's connectors are all conveniently located on one end:



### High current connections

These controllers have four high-current busbars: **B+**, **B-**, **A2**, and **M-**. The busbars are tin-plated solid copper.

Table 1 High Current Connections	
<b>B+</b>	Battery+ and motor armature. (plug diode -)
<b>B-</b>	B-.
<b>A2</b>	Motor armature and field (plug diode +).
<b>M-</b>	Motor field (controller output).

Cables used for the battery and motor connections must be heavy enough to carry the high current required. A minimum size of 25 mm<sup>2</sup> (#4 AWG) is recommended.

Connections to the controller busbars should be made with lugs suitable for the cable used, fastened by M8 bolts and nuts. **When tightening the bolts, two opposing wrenches should be used.** Failure to use the double-wrench technique could cause undue strain to be placed on the internal connections, and could also result in cracked seals around the busbars.

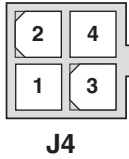
### Low current connections

These controllers have five low-current connections: four 6.35 mm push-on terminals (**J1**, **J2**, **J3**, and **J5**), and one 4-pin connector (**J4**).

Table 2 Low Current Connections	
<b>J1</b>	Keyswitch.
<b>J2</b>	Wire 1 of 2-wire throttle; Pot High of 3-wire or ITS throttle.
<b>J3</b>	Wire 2 of 2-wire throttle; Pot Wiper of 3-wire throttle; Pot Low of ITS throttle; or electronic throttle input.
<b>J4</b>	4-pin connector: <i>see Table 3.</i>
<b>J5</b>	Reverse signal output / main contactor coil driver.

For the control wiring, 0.75 mm<sup>2</sup> (#18 AWG) vinyl insulated stranded wire is recommended.

The mating connector for **J4** is a 4-pin Molex Mini-fit Jr. or equivalent. Either an external Status LED or a Curtis programmer can be connected to J4. The pinout is as follows.



PIN	PROGRAMMER	STATUS LED
<b>J4-1</b>	Data input from programmer (Rx).	Status LED enable.
<b>J4-2</b>	Ground.	Ground.
<b>J4-3</b>	Data output to programmer (Tx).	Status LED output.
<b>J4-4</b>	+15 V.	+15 V.

Note: When J4 is used for a Status LED, a jumper must be added between pins J4-1 and J4-4 as shown in the basic wiring diagram (Figure 3).

## CONTROLLER WIRING: BASIC CONFIGURATIONS

Two basic wiring diagrams are shown; they are identical except for the wiring at terminal J5. In the configuration in Figure 4, the main contactor driver is active. In the configuration in Figure 5, the reverse input is active.

### Wiring with active main contactor

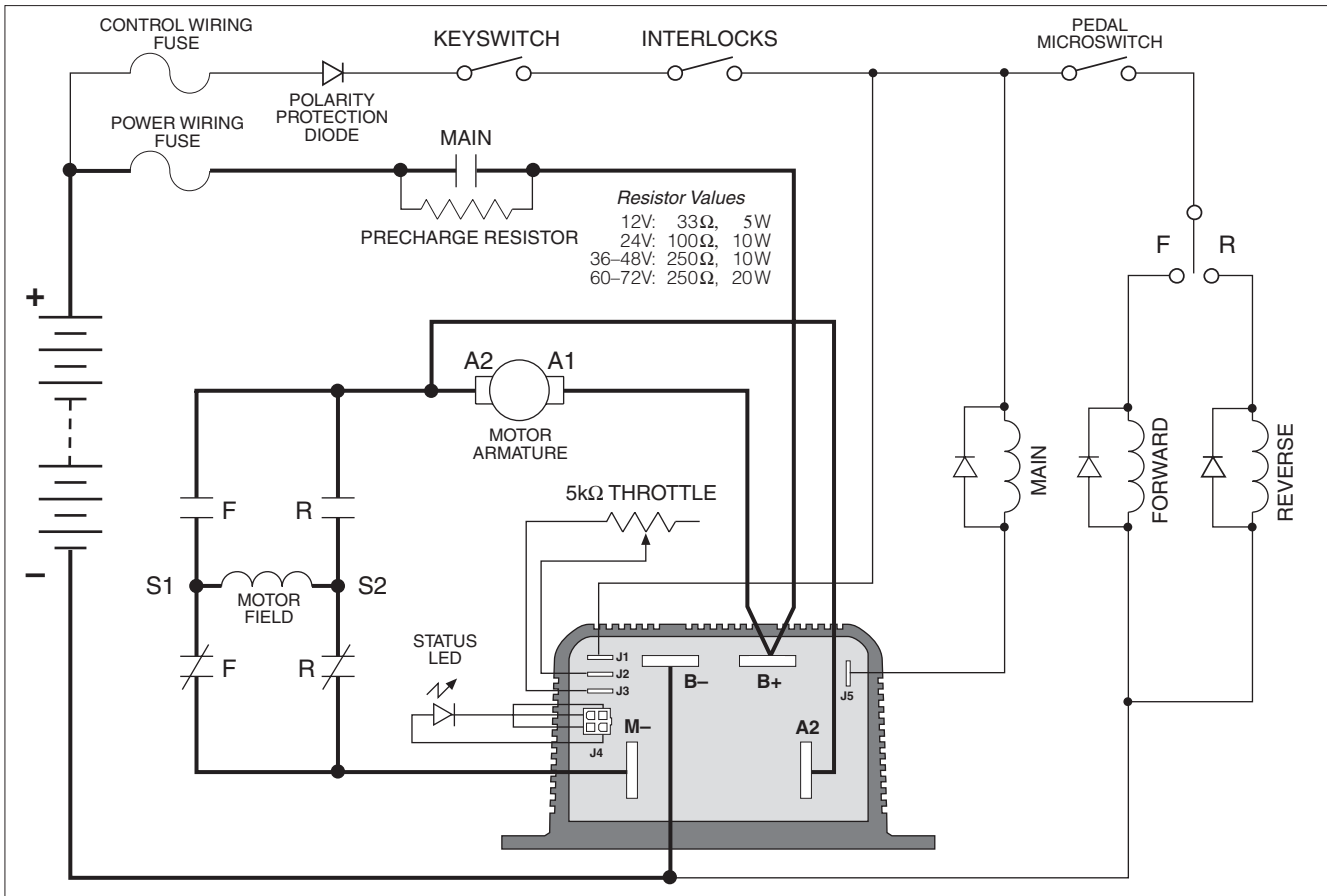
For this option, set the Rev Input / Main Driver parameter = 2 (see page 24), and wire the controller as shown in Figure 4.

J5 is used to drive the main contactor, which will open the battery power in the event of a severe fault; this will help to meet safety regulations. If you wish to limit reverse speed, you will need to add a speed reduction resistor.

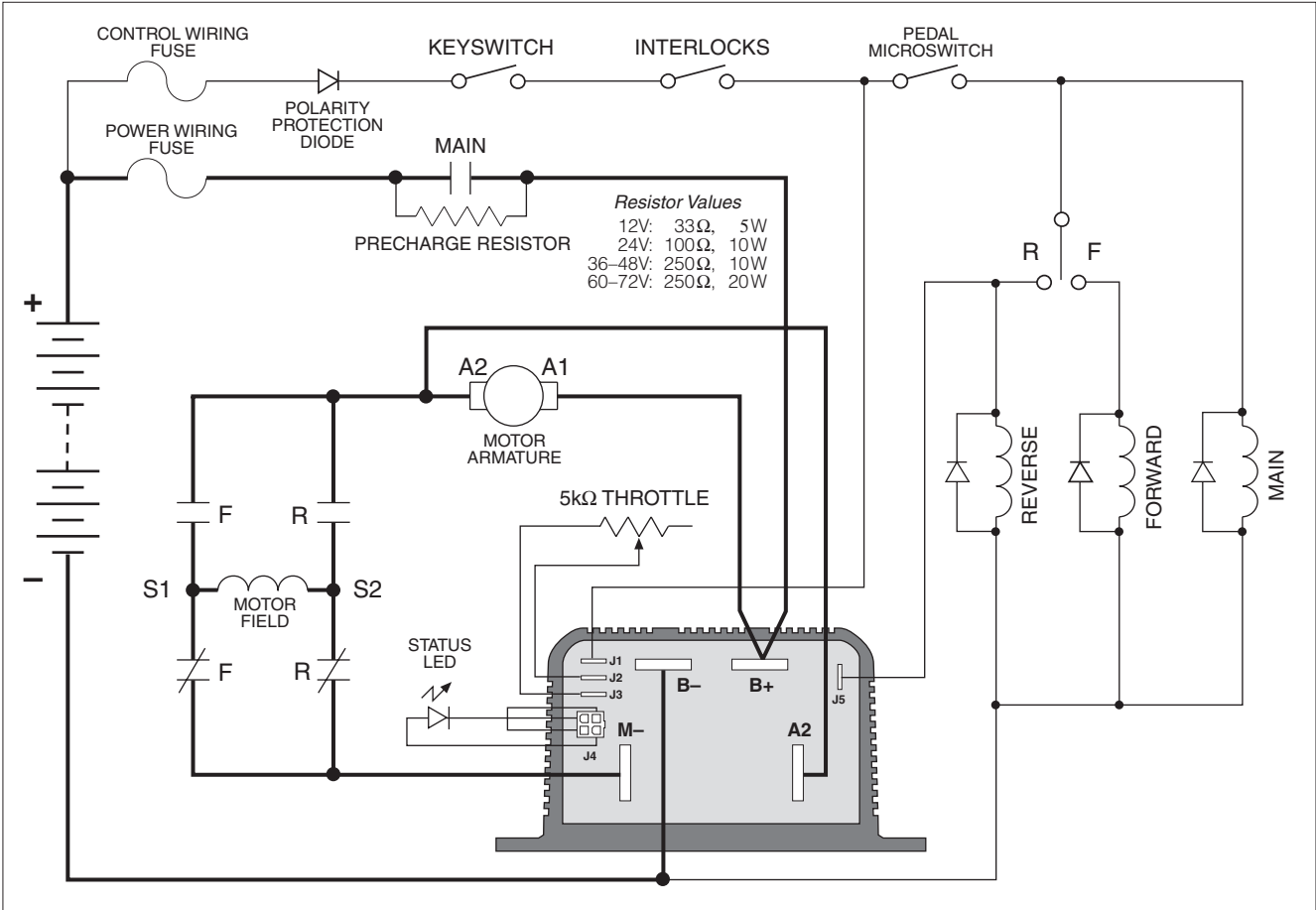
### Wiring with active reverse input

For this option, set the Rev Input / Main Driver parameter = 1 (see page 24), and wire the controller as shown in Figure 5.

J5 is used as the input when the reverse direction is selected. This simplifies the wiring for limiting reverse speed; the speed in reverse is limited by the setting of the Rev Speed parameter. However, with this configuration the main contactor does not open the battery power in the event of a severe fault.



**Fig. 4** Basic wiring diagram, Curtis 1204M/05M/09M/21M *with active main contactor*.



**Fig. 5** Basic wiring diagram, Curtis 1204M/05M/09M/21M *with active reverse input.*

The throttle shown in the basic wiring diagrams is a 2-wire potentiometer. Various types of throttles can be used; see Throttle Type parameter (page 21) and throttle wiring (pages 10–13).

Coil suppression diodes should be used on the main and forward/reverse contactors, as shown.

### KSI Wiring

The keyswitch input (KSI) circuit includes input from the keyswitch and from the various interlocks. The controller KSI is used to turn the controller on and off. KSI is turned on by connecting it to battery B+. Any positive voltage greater than about 16 volts will turn on the controller, but usually the full vehicle battery voltage is used. KSI draws up to 130 mA with the programmer connected, and up to 70 mA without the programmer.

In its simplest form, KSI is operated by a keyswitch that turns the vehicle off and prevents unauthorized use. The keyswitch should also turn off the main contactor and the forward/reverse contactors. This will act as a safety feature by removing power from the motor control system when the keyswitch is turned off.

Interlocks (seat switches, battery charger interlocks, etc.) should be wired in series so that they turn off the controller KSI and the contactors.

### Forward/Reverse Wiring

With these controllers, **it is essential that the field be reversed and that the armature be connected directly to the controller's B+ and A2 terminals, because the plug diode inside is connected to these terminals;** this is the wiring shown in Figures 4 and 5. Some vehicles, especially those previously using older, resistor-type controllers, may reverse the motor armature rather than the field winding. Be careful if you are replacing this type of controller.

#### Plug braking

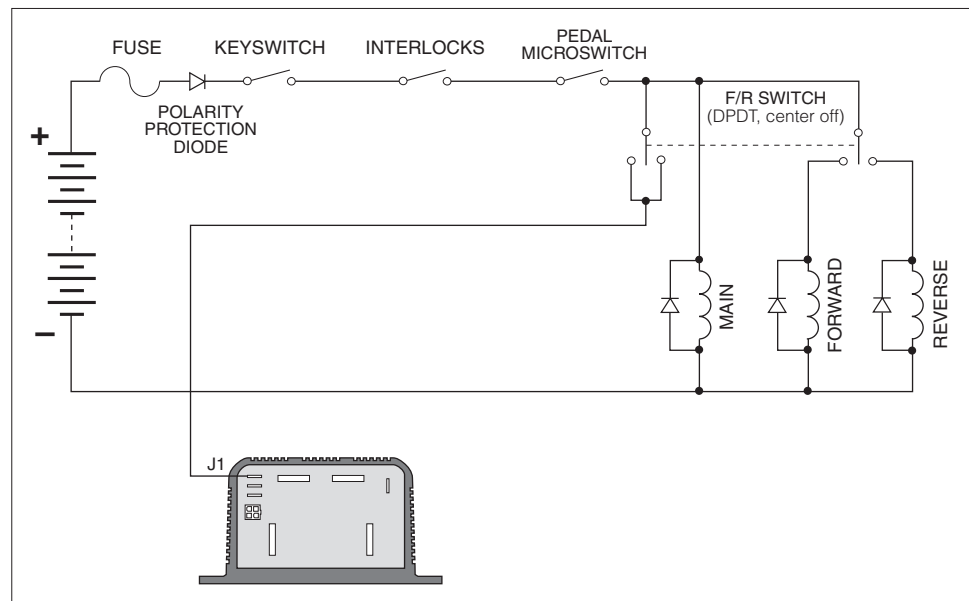
Wired as shown in the basic wiring diagrams, the vehicle will plug brake if the direction is changed with the vehicle moving and the throttle applied. The forward/reverse switch should be in the positive feed to the contactor coils, so that they can be turned off by the keyswitch and any interlocks. The coil of one contactor or the other is energized to select the direction desired.

#### Freewheeling (wiring to inhibit plug braking)

If plug braking is not desired, the vehicle can be wired so that moving the forward/reverse switch through neutral causes the vehicle to freewheel as long as the throttle is applied. Plug braking can be reactivated during freewheeling by releasing the throttle and reapplying it. The HPD option must be enabled (programmed On) in order for this arrangement to work.

As shown in Figure 6, another set of contacts is added on the forward/reverse switch. Therefore, a double-pole, double-throw (DPDT) center-off switch must be used for this setup. A “hesitation switch” is recommended, to ensure the switch is in neutral long enough to actuate HPD and inhibit plug braking.

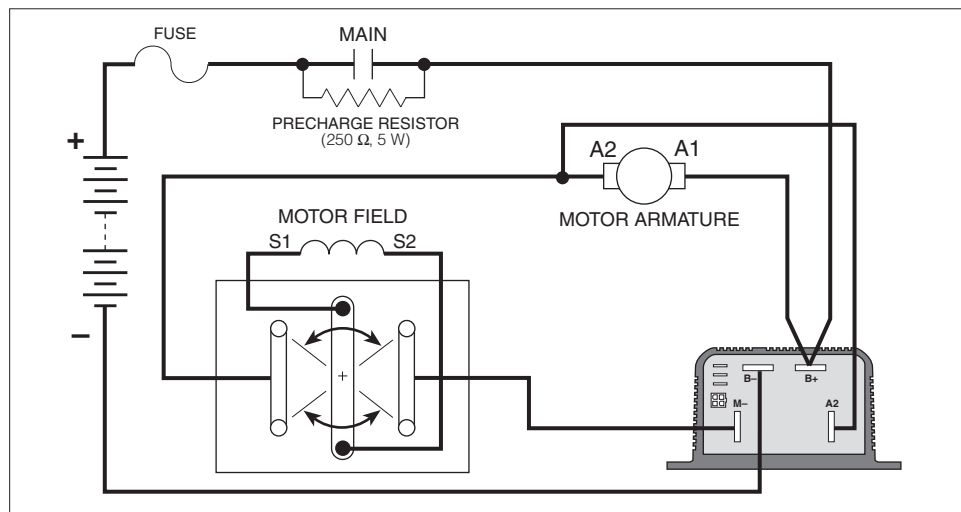
**Fig. 6** Control wiring to inhibit plug braking, in order to allow freewheeling.



*Wiring for mechanical reversing switch (golf car type)*

As shown in Figure 7, this type of switch mechanically interchanges the two motor field cables by rotating a movable contact bar. The configuration shown is typical; many variations are in use.

**Fig. 7** *Wiring for reversing with a mechanical F/R switch arm.*



**Throttle Wiring**

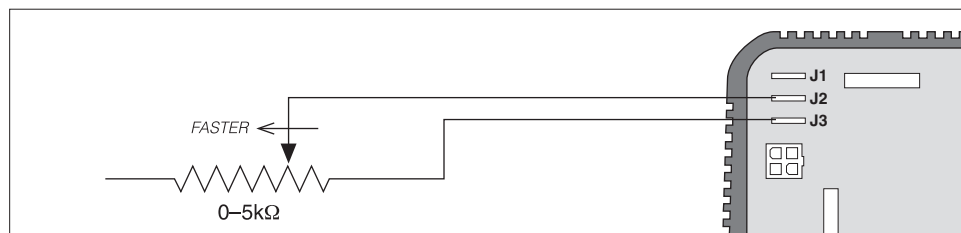
Ten throttle types can be used with these controllers:

- Type 0 2-wire potentiometer, 0–5kΩ
- Type 1 2-wire potentiometer, 5kΩ–0
- Type 2 single-ended 0–5V input
- Type 3 2-wire potentiometer, 4.6kΩ–0
- Type 4 2-wire potentiometer, 5.5kΩ–0
- Type 5 2-wire potentiometer, 1kΩ–0
- Type 6 ITS input
- Type 7 single-ended 6.3–10.6 V input
- Type 8 single-ended 6–12 V input
- Type 9 single-ended 3-wire potentiometer, 0–5kΩ

*Throttle Type 0*

Wiring for Type 0 throttles is simple: just connect the two wires to the J2 and J3 push-on terminals; it doesn't matter which wire goes on which terminal. With Type 0 throttles, resistance increases as the applied throttle is increased.

**Fig. 8** *Wiring for Type 0 throttles.*



Mechanical potboxes and footpedals are Type 0 throttles. It doesn't matter which wire goes on which terminal, and the wires can be extended as required.

Some potboxes have a built-in microswitch, eliminating the need to install a separate pedal-actuated microswitch. It is important that a pedal microswitch be included in the circuit as shown in Figures 4 and 5 to allow the microcontroller a few milliseconds to boot up, run diagnostics and safety checks, and then be ready in standby before receiving the throttle signal.

A potbox makes it easy to retain the vehicle's original cable throttle pedal. Curtis and various third-party vendors also offer self-contained footpedal units that eliminate the need for fabricating and installing a pedal-potbox linkage. Any potbox that can provide a nominal 0–5k $\Omega$  output will work as a Type 0 throttle input.

If a potbox is used, it must be mounted so as to allow connection between the potbox lever arm and the vehicle accelerator linkage. Use of a second return spring on the pedal, in addition to the potbox return spring, is required to prevent an uncontrollable full-on throttle input (which could happen if there was a single spring, and it broke). If the self-contained potbox spring is insufficient to return the pedal by itself, two additional pedal return springs must be used.

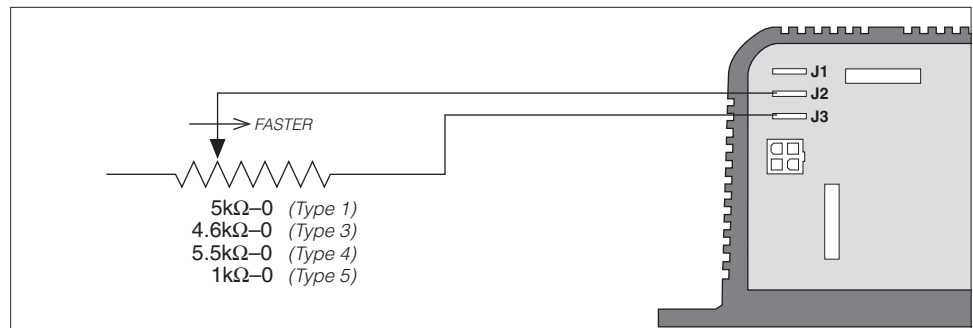
It is also required that the accelerator pedal hit a mechanical stop at its full-on position just before ( $\approx 1$  mm) the potbox lever hits its own full-on stop. This mechanical stop will prevent the potbox lever arm from bending if undue force is put on the pedal. Protection of the potbox from water and dirt will help avoid problems of corrosion and electrical leakage.

After the potbox has been mounted, operation of the pot can be tested by measuring the resistance between the two wires with an ohmmeter. With the pedal not applied, the resistance should be less than 50 ohms. As the pedal is applied, the resistance should rise smoothly until it reaches a value between 4500 and 5500 ohms. Values below 4500 ohms may cause a reduction in efficiency and top speed; however, you still can get top speed by lowering the Throttle Max setting. Values above 7500 ohms indicate a defective potbox, and will cause controller shutdown.

#### Throttle Types 1, 3, 4, 5

Wiring for Type 1, 3, 4, and 5 throttles is the same as for Type 0 throttles; again, it doesn't matter which wire goes on which terminal. With these throttles, resistance is in an inverse relationship to applied throttle; that is, resistance decreases as applied throttle is increased.

**Fig. 9** Wiring for Type 1, 3, 4, and 5 throttles.



#### *Throttle Type 2*

With Type 2 throttles, the controller looks for a voltage signal at J3. Zero throttle request corresponds to 0 V and full throttle request to 5 V. A variety of devices can be used with this throttle input type, including voltage sources, current sources, and electronic throttles. The wiring for each is slightly different, as shown in Figure 10, and they have varying levels of throttle fault protection.

When a voltage source is used as a throttle, it is the responsibility of the OEM to provide appropriate throttle fault detection. For ground-referenced 0–5V throttles, the controller will detect open breaks in the wiper input but cannot provide full throttle fault protection.

To use a current source as a throttle, a resistor must be added to the circuit to convert the current source value to a voltage; the resistor should be sized to provide a 0–5V signal variation over the full current range. It is the responsibility of the OEM to provide appropriate throttle fault detection.

The Curtis ET-XXX electronic throttle contains no built-in fault detection, and the controller will detect only open wiper faults. It is the responsibility of the OEM to provide any additional throttle fault detection necessary. For wiring other electronic throttles, consult the instructions that are provided with the throttle.

There are many electronic footpedals on the market; for wiring, consult the instructions that are provided with the footpedal.

#### *Throttle Type 6*

The ITS+ connects to J2, and ITS- connects to J3.

#### *Throttle Types 7, 8*

Wiring for these voltage input throttles is the same as for Type 2 throttles; the throttle input goes to J3 and the ground return to B-.

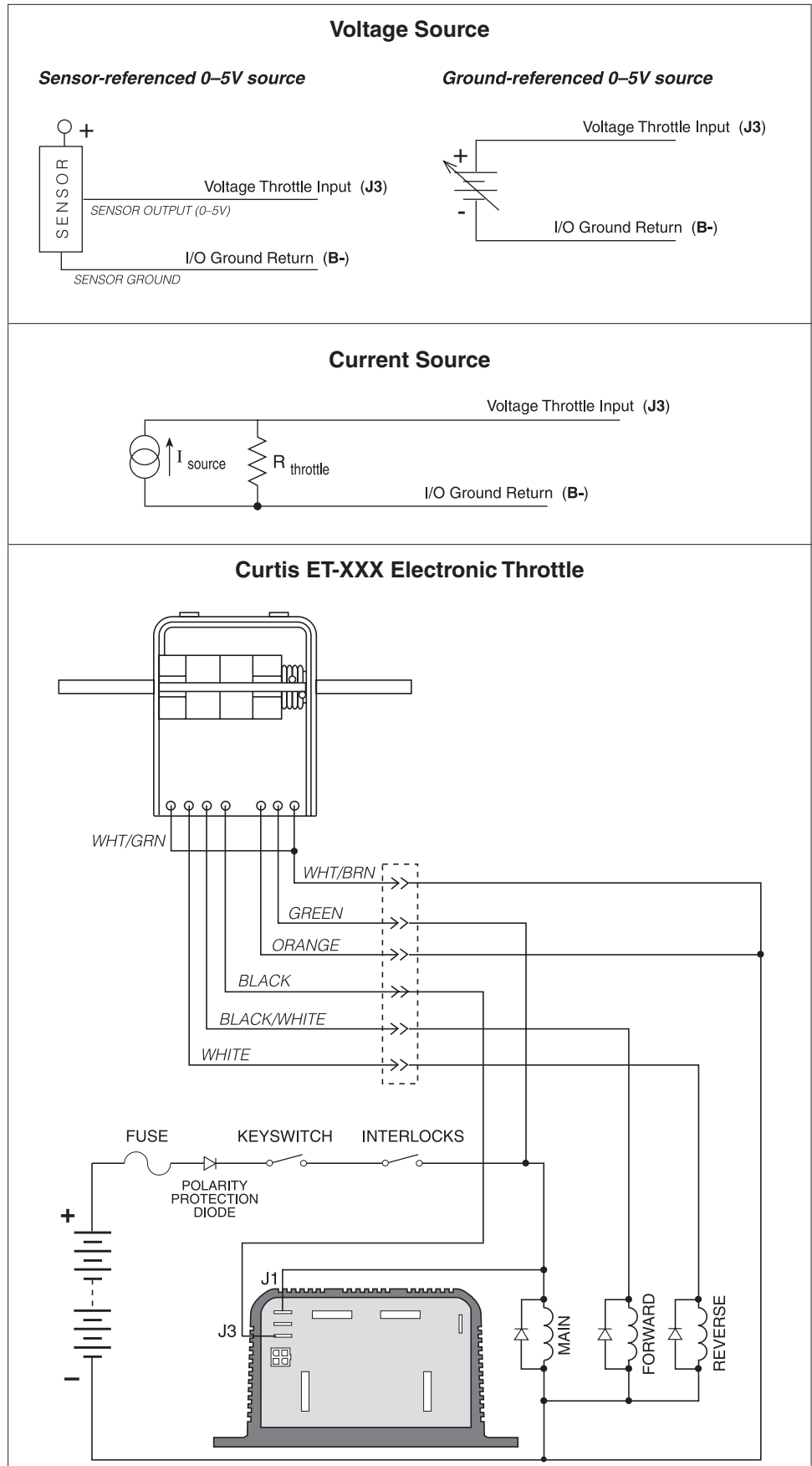
#### *Throttle Type 9*

The Pot High input goes to J2, the Pot Wiper goes to J3, and the ground return goes to B-. No signals to the controller's forward and reverse inputs are required, because the direction is determined by the wiper input value. The neutral point will be with the wiper at 2.5 V, measured between the pot wiper input (J3) and I/O ground return (B-). The controller will provide increasing forward speed as the wiper input is increased from the neutral point, and increasing reverse speed as the wiper input value is decreased from the neutral point.

When a 3-wire pot is used, the controller provides full fault protection.

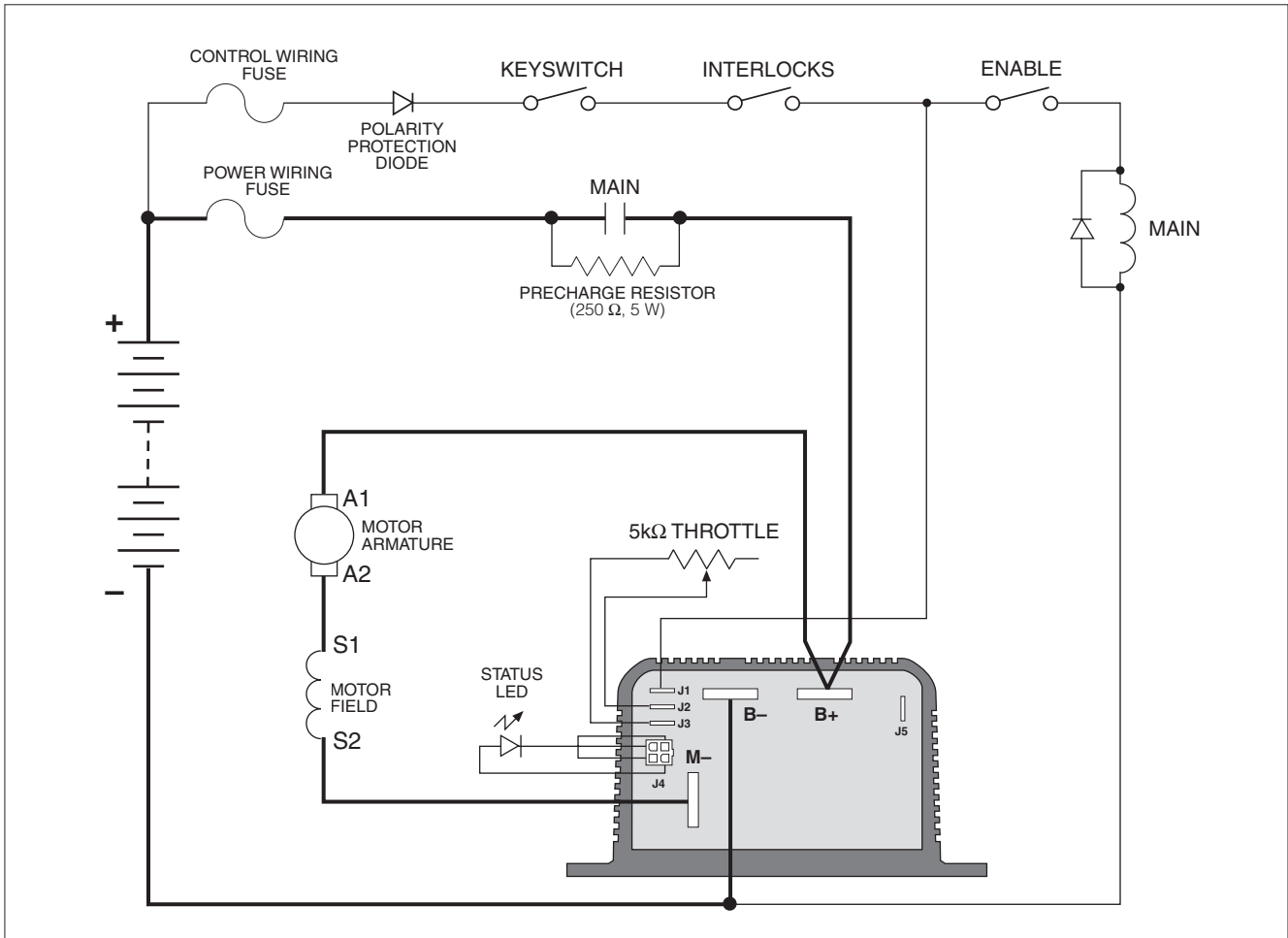


**Fig. 10** *Wiring for Type 2 throttles.*



### Basic Wiring Configuration for Pump Applications

The 1204M-6302 controller has only three busbars; it is appropriate for use with pump motors, wired as shown in Figure 11.



**Fig. 11** Basic wiring diagram, Curtis 1204M-6302 motor controller—for pump applications.

## INSTALLATION CHECKOUT

Carefully complete the following checkout procedure before operating the vehicle. If a step does not test correctly, refer to Section 5: Diagnostics and Troubleshooting.



*Put the vehicle up on blocks to get the drive wheels off the ground before beginning these tests.*

*Don't let anyone stand in front of or behind the vehicle during the checkout.*

*Make sure the keyswitch is off and the vehicle is in neutral before beginning.*

*Wear safety glasses and use well-insulated tools.*

A. Connect the battery. Use a voltmeter to verify that the proper voltage and polarity appears at the battery B+ and B- terminals.

B. Check the voltage at the controller B+ and B- busbars. If your system has a precharge resistor in parallel with the main contactor, you should see approximately 90% of the full battery voltage. If your system does not have a resistor, temporarily connect one (100 to 200 ohms, 5 watts, or a 100 watt light bulb). The voltage at the controller should rise to approximately 90% of the full battery voltage.

C. If “A” and “B” do not check out, troubleshoot the wiring connections. **Do not turn on the keyswitch until the trouble is corrected and “A” and “B” check out.**

D. With the forward/reverse switch in neutral, turn on the keyswitch. If the motor runs without the throttle being applied, turn the keyswitch off and recheck the wiring. If the motor does **not** run without the throttle applied, proceed with the checkout. Select a direction and slowly apply the throttle; the motor should now respond.

E. Look to see which direction the wheels are turning. If the wheels are going the wrong way, turn everything off and interchange the motor field connections.

F. If you have HPD, check it next. Turn off the keyswitch and direction switch. Apply the throttle, turn the keyswitch on, and then select a direction. The motor should not run. Release the throttle and re-apply it — the motor should now run. If the motor runs before you release the throttle, recheck the wiring.

G. Take the vehicle down off the blocks and drive it in a clear area. It should have smooth acceleration and good top speed.

H. On vehicles that are intended to plug brake, test the plug braking by driving forward at moderate speed and shifting into reverse without letting up on the throttle. The vehicle should smoothly brake to a stop and accelerate in reverse.

I. On vehicles that are intended to have plug braking inhibited, verify that the maneuver in “H” produces freewheel coasting.

# 3

## PROGRAMMABLE PARAMETERS

The 1204M/05M/09M/21M controllers have a number of parameters that can be adjusted using a Curtis programming device. These programmable parameters allow the vehicle's performance to be customized to fit the needs of specific applications.

The programmable parameters are displayed in five submenus within the Program menu (on the 1311 handheld programmer) or the Parameters menu (on the 1313 handheld programmer or 1314 PC Programming Station).

### *Voltage*

- Battery Voltage
- Undervoltage Cutback
- Undervoltage Cutback Rate
- Undervoltage Cutoff

### *Current*

- Main Current Limit
- Plug Current Limit

### *Speed*

- Accel Rate
- Quick Start
- Max Speed
- Rev Speed

### *Throttle*

- Throttle Type
- Throttle Deadband
- Throttle Max
- Throttle Map

### *Misc*

- HPD
- Variable Plug
- Boost
- Contactor Protection
- Main Drop Delay
- Rev Input / Main Driver

The individual parameters are presented as follows in the parameter charts:

Parameter name as it appears in the programmer display	Allowable range in the programmer's units	Description of the parameter's function and, where applicable, suggestions for setting it
↓	↓	↓
<b>Max Speed</b>	0–100 %	Defines the maximum motor speed at full throttle, as % PWM.

<b>VOLTAGE MENU</b>		
PARAMETER	ALLOWABLE RANGE	DESCRIPTION
<b>Battery Voltage</b>	1–6	<p>Set this parameter to match the battery pack of your vehicle.</p> <p>1 = 12 V            2 = 24 V            3 = 36 V            4 = 48 V            5 = 60 V            6 = 72 V.</p>
<b>Under Voltage Cutback</b>	68–100 %	<p>The controller's circuitry requires a minimum battery voltage to function properly. When battery voltage drops, reducing the controller's output to the motor allows the battery to recover. The Under Voltage Cutback parameter sets the threshold voltage below which controller output will start to be reduced.</p> <p style="text-align: center;">The programmed value is a percentage of the battery voltage.</p>
<b>Under Voltage Cutback Rate</b>	0–110 A	<p>The Under Voltage Cutback Rate determines how quickly the controller output will be reduced when battery voltage falls below the programmed Under Voltage Cutback threshold.</p> <p style="text-align: center;">The programmed value is the amount the current will be reduced for every 0.4 V the battery voltage decreases.</p> <p style="text-align: center;">Larger values represent faster reduction of controller output.</p> <p style="text-align: center;">Setting Under Voltage Cutback Rate = 0 means there will be no undervoltage cutback.</p>
<b>Under Voltage Cutoff</b>	67–100 %	<p>The Under Voltage Cutoff parameter sets the voltage at which controller output will be cut off completely.</p> <p style="text-align: center;">The programmed value is a percentage of the battery voltage.</p>

CURRENT MENU		
PARAMETER	ALLOWABLE RANGE	DESCRIPTION
<b>Main Current Limit</b>	50 A – rated current	The main current limit can be programmed, in 5A increments, up to the controller's 2-minute current rating (see model chart in Appendix C).
<b>Plug Current Limit</b>	50–250 A	<p>Plug braking occurs when the opposite direction is selected with the forward/reverse switch without releasing the throttle. The vehicle brakes smoothly to a stop and then accelerates in the other direction.</p> <p>The plug braking current limit is set by this parameter.</p> <p>Plug braking can be either fixed or throttle-variable; see Variable Plug parameter (page 23). During fixed plug braking, the plug braking current is the programmed Plug Current Limit value. During variable plug braking, the plug braking current varies with the amount of applied throttle, from 50% to 100% of the programmed Plug Current Limit value.</p>

SPEED MENU		
PARAMETER	ALLOWABLE RANGE	DESCRIPTION
<b>Accel Rate</b>	0.2–3.0 s	<p>The Accel Rate defines the time it takes the controller to accelerate from 0% output to 100% output when full throttle is applied.</p> <p>Larger values represent a longer acceleration time and therefore a gentler start. For faster starts, adjust the Accel Rate to a smaller value.</p>
<b>Quick Start</b>	0.2–3.0 s	<p>When the throttle is moved from zero rapidly, the quick start feature is activated. The Quick Start acceleration rate then replaces the normal acceleration rate (as set by the Accel Rate parameter).</p> <p>The Quick Start parameter can only be set to values smaller (faster) than the programmed Accel Rate.</p>
<b>Max Speed</b>	20–100 %	<p>Defines the maximum requested motor speed at full forward throttle, as % PWM. Partially-applied throttle is scaled proportionately; e.g., 40% applied throttle corresponds to a request for 40% of the programmed Max Speed value. Example: if Max Speed is set to 80%, a 40% applied forward throttle corresponds to a 32% request (<math>0.80 * 0.40 = 0.32</math>).</p>
<b>Rev Speed</b>	40–100 %	<p>Defines the maximum requested motor speed at full reverse throttle, as % PWM. Partially-applied throttle is scaled proportionately; e.g., 40% applied throttle corresponds to a request for 40% of the programmed Max Speed value. Example: if Max Speed is set to 80%, a 40% applied reverse throttle corresponds to a 32% request (<math>0.80 * 0.40 = 0.32</math>).</p> <p>The Rev Speed parameter is in effect only with the “reverse input active” wiring configuration or with a speed reduction resistor added to the circuit.</p>



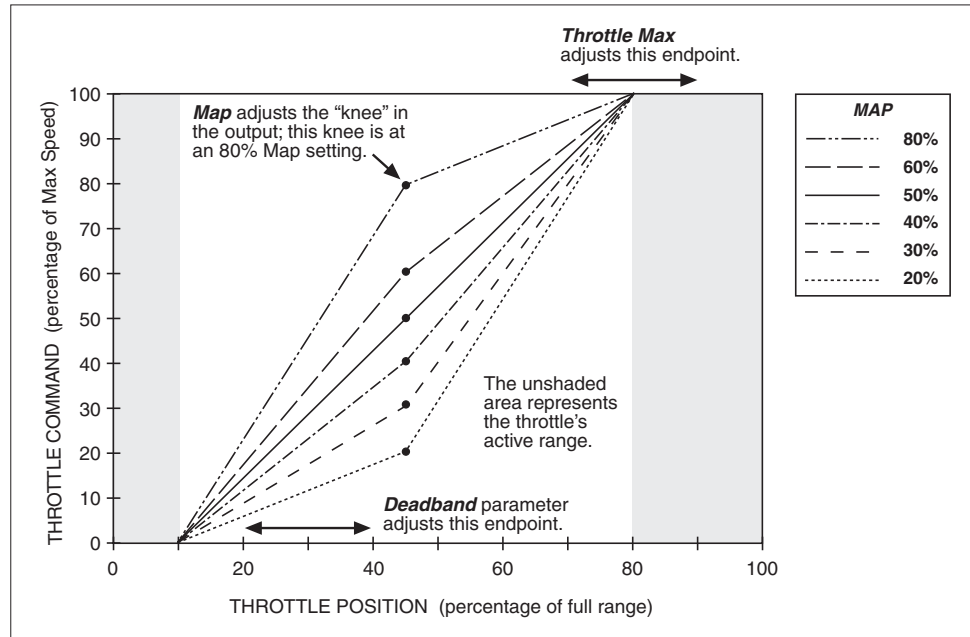
THROTTLE MENU		
PARAMETER	ALLOWABLE RANGE	DESCRIPTION
<b>Throttle Type</b>	0–9	<p>The 1204M/05M/09M/21M controllers accept a variety of throttle inputs. The Throttle Type parameter can be programmed as follows:</p> <ul style="list-style-type: none"> <li>0 2-wire potentiometer, 0–5k<math>\Omega</math> input</li> <li>1 2-wire potentiometer, 5k<math>\Omega</math>–0 input</li> <li>2 single-ended 0–5V input</li> <li>3 2-wire potentiometer, 4.6k<math>\Omega</math>–0 input</li> <li>4 2-wire potentiometer, 5.5k<math>\Omega</math>–0 input</li> <li>5 2-wire potentiometer, 1k<math>\Omega</math>–0 input</li> <li>6 ITS input</li> <li>7 6.3–10.6 V input</li> <li>8 6–12 V input</li> <li>9 single-ended 3-wire potentiometer, 0–5k<math>\Omega</math> input.</li> </ul>
<b>Throttle Deadband</b>	4–90 %	<p>The Throttle Deadband parameter defines the neutral deadband as a percentage of the full throttle range. Increasing the Throttle Deadband setting will increase the neutral range. This parameter is especially useful with throttle assemblies that do not reliably return to a well-defined neutral point, because it allows the deadband to be defined wide enough to ensure that the controller goes into neutral when the throttle mechanism is released.</p>
<b>Throttle Max</b>	10–100 %	<p>The Throttle Max parameter defines the percentage of throttle movement at which 100% output is requested. Decreasing the Throttle Max setting reduces the full stroke necessary to produce full controller output. This parameter allows reduced-range throttle assemblies to be accommodated.</p>
<b>Throttle Map</b>	20–80 %	<p>The Throttle Map parameter modifies the vehicle's response to the throttle input. Setting Throttle Map at 50% provides a linear output response to throttle position. Values below 50% reduce the controller output at low throttle settings, providing enhanced slow speed maneuverability. Values above 50% give the vehicle a faster, more responsive feel at low throttle settings.</p> <p>The Throttle Map value is the controller output at half throttle, as a percentage of the Max Speed. Half throttle is the midpoint of the throttle's active range, which is the range from zero output (at the Deadband setting) to 100% output (at the Throttle Max setting).</p>

The Throttle Deadband, Throttle Max, and Throttle Map parameters work together to condition the throttle command, as shown in Figure 12.

**Fig. 12** Effect of throttle adjustment parameters.

In the examples shown in this figure,

*Deadband* = 10%  
*Throttle Max* = 80%.



MISCELLANEOUS PARAMETERS		
PARAMETER	ALLOWABLE RANGE	DESCRIPTION
<b>HPD</b>	On/Off	<p>By preventing the vehicle from being turned on with the throttle applied, the HPD feature ensures the vehicle starts smoothly and safely. To start, the controller must receive an input to KSI before receiving a throttle input. In addition to providing routine smooth starts, HPD also protects against accidental sudden starts if problems in the linkage (such as bent parts or a broken return spring) give a throttle input signal to the controller even with the throttle released.</p> <p>When programmed On, the HPD feature is enabled. This is required for full throttle protection.</p> <p>When programmed Off, the HPD feature is not enabled.</p>
<b>Variable Plug</b>	On/Off	<p>Plug braking occurs when the opposite direction is selected with the forward/reverse switch without releasing the throttle. The vehicle brakes smoothly to a stop and then accelerates in the other direction.</p> <p>When Variable Plug is programmed On, the plug braking current varies with the amount of applied throttle. The range is from 50% to 100% of the programmed Plug Current Limit (see page 19).</p> <p>When Variable Plug is programmed Off, plug braking is fixed at the current set by the programmed Plug Current Limit.</p>
<b>Boost</b>	On/Off	<p>In situations where the controller detects that the motor is about to stall, the boost feature provides a short burst of extra torque by briefly applying a current higher than the rated current. This can be useful for occasionally getting the vehicle out of a pothole or over an obstacle.</p> <p>Setting the Boost parameter On enables the boost feature.</p> <p>If the Boost parameter is set to Off, the controller's output is limited to its rated current.</p>
<b>Contactors Protection</b>	On/Off	<p>The Contactors Protection parameter can be used to protect the tips of the F/R contactors and main contactor from possible damage due to high current arcs.</p> <p>If the Contactors Protection parameter is programmed On, when the controller detects the throttle is released (within the throttle deadband) it will immediately cut off the PWM output, and because the current is cut off quickly the contactor tips will be opened with no high current arcs. Similarly, when a F/R contactor is open, the controller will lock the PWM output so that when the contactor starts to close again, there is no current on the tips.</p> <p>If programmed Off, this protection is lost. However, the PWM will decrease at the set deceleration rate instead of abruptly, resulting in a smoother stop—which may be desired in some applications.</p>
<b>Main Drop Delay</b>	0–60 s	<p>The Main Drop Delay defines the time delay before the main contactor drops out after there has been no active throttle signal.</p> <p>Setting Main Drop Delay = 0 means the main contactor never drops out; it does not mean there is no delay.</p>

**MISCELLANEOUS PARAMETERS, continued**

PARAMETER	ALLOWABLE RANGE	DESCRIPTION
<b>Rev Input / Main Driver</b>	0–2	<p>This parameter determines the signal input at the controller's J5 terminal; see basic wiring diagrams, Figures 4 and 5.</p> <p>0 = reverse input and main driver both inactive; use this setting if you are replacing an earlier model with no J5 terminal and want to leave the wiring as it was.</p> <p>1 = Reverse input active (see page 7 description, and Figure 5).</p> <p>2 = Main driver active (see page 7 description, see Figure 4).</p>

**CLONING (for copying parameter settings to multiple controllers)**

Once a controller has been programmed to the desired settings, these settings can be transferred as a group to other controllers, thus creating a family of “clone” controllers with identical settings. **Cloning only works between controllers with the same model number.** For example, the programmer can read all the information from a 1209M-5501 controller and write it to other 1209M-5501 controllers; however, it cannot write that same information to 1209M-6401 controllers.

To perform cloning with the 1311 handheld programmer, plug the programmer into the controller that has the desired settings. Scroll down to the Functions menu; “Settings” is the only function included here. Select “Get settings from controller” to copy the settings into the programmer.

Plug the programmer into the controller that you want to have these same settings, and select “Write settings to controller.”

To perform cloning with the 1313 handheld programmer or 1314 PC Programming Station, use the Programming menu.

## 4

**MONITOR MENU**

Through its Monitor menu, the programmer provides access to real-time data during vehicle operation. This information is helpful during diagnostics and troubleshooting, and also while adjusting programmable parameters.

<b>MONITOR MENU</b>		
<b>VARIABLE</b>	<b>DISPLAY UNITS</b>	<b>DESCRIPTION</b>
<b>Heatsink Temp</b>	°C	Heatsink temperature.
<b>Throttle</b>	%	Throttle request, as percentage of full throttle.
<b>Duty Cycle</b>	%	Controller's PWM output, as percentage of programmed Max Speed.
<b>Cap Voltage</b>	V	Voltage of controller's internal capacitor bank at B+ busbar.
<b>A2 Voltage</b>	V	Voltage on controller's A2 busbar.
<b>Battery Voltage</b>	V	Battery voltage.
<b>Motor Voltage</b>	V	Voltage between controller's B+ and M- busbars.
<b>Motor Open</b>	On/Off	Status of motor connection.
<b>Plug Braking</b>	On/Off	Status of plug braking feature.

## 5

## DIAGNOSTICS AND TROUBLESHOOTING




















The 1204M/05M/09M/21M controllers detect a wide variety of faults or error conditions. Fault information can be obtained in either of two ways: (1) by observing the fault codes issued by the external Status LEDs or (2) by reading the display on a programmer. Because the programmer uses the same connector as the Status LED, only one of these ways can be used at any given time.

## LED DIAGNOSTICS

During normal operation, with no faults present, the Status LED flashes steadily. If the controller detects a fault, a 2-digit fault code is flashed until the fault is corrected. For example, code “2,3”—HPD—appears as:

□□ □□□	□□ □□□	□□ □□□
( 2 , 3 )	( 2 , 3 )	( 2 , 3 )

Table 4 STATUS LED FAULT CODES

LED CODES	EXPLANATION
<i>LED off</i> 	no power or defective controller
<i>solid on</i> 	controller or microprocessor fault
0,1 	controller operational; no known faults
1,1 	EEPROM fault
1,2 	MOSFET short fault
1,3 	[not used]
1,4 	wiring fault
2,1 	under voltage cutoff
2,2 	[not used]
2,3 	HPD sequencing error
2,4 	throttle fault
3,1 	main contactor coil short / driver fault
3,2 	main contactor weld fault
3,3 	main contactor driver fault
3,4 	main contactor DNC (missing or open)
4,1 	under voltage cutback, low battery voltage
4,2 	over voltage
4,3 	thermal cutback, due to over/under temperature
4,4 	over temperature cutoff, due to severe overtemperature(>110°C)

Note: Only one fault is indicated at a time. Faults are not queued up.

The numerical codes are listed in the troubleshooting chart (Table 5), which also lists effects, clear conditions, and possible causes for each fault.

## PROGRAMMER DIAGNOSTICS

The programmer's Faults menu (1311 programmer) / Diagnostics menu (1313 programmer) displays the faults that are currently set, by name. The programmer's Monitor menu displays various readouts that can be helpful during diagnostics; see Section 4.

For example, in the event of an undervoltage cutback fault, the words **Undervoltage Cutback** will be displayed in the Faults/Diagnostics menu. The real-time battery voltage is displayed in the Monitor menu ("Battery Voltage").

The programmer also can display a history of all the faults that have been set since the history log was last cleared.

## TROUBLESHOOTING

The detection of a fault causes the controller to operate in a manner that is safe in the presence of that fault. Depending on the severity of the fault, the response can range from reducing current to complete shutdown.

The troubleshooting chart, Table 5, provides the following information on all the controller faults:

- fault code
- fault name as displayed on the programmer's LCD
- the effect of the fault
- fault clear conditions
- possible causes of the fault.

Some faults can be self-cleared; for example, an undervoltage fault will clear when the battery voltage returns to an acceptable level. Whenever a fault is encountered and no wiring or vehicle fault can be found, shut off KSI and turn it back on to see if the fault clears. If not, shut off KSI and remove the J-1, J-2, J-3, and J-5 connectors. Check the connectors for corrosion or damage, clean them if necessary, and re-insert them.

**Table 5 TROUBLESHOOTING CHART**

LED CODE	PROGRAMMER LCD DISPLAY	EFFECT OF FAULT	RECOVERY	POSSIBLE CAUSE
1,1	EE Fault	PWM output disabled.	Modify any programmable parameter with programmer.	1. EEPROM data lost or damaged. 2. EEPROM checksum error.
1,2	MOSFET Short Fault	PWM output disabled.	Cycle KSI.	1. MOSFET shorted.
1,4	Wiring Fault	PWM output disabled.	Cycle KSI.	1. HPD Lockout exists for more than 10 seconds.
2,1	Under Voltage Cutoff	PWM output disabled.	Battery voltage rises above Under Voltage Cutback threshold.	1. Battery voltage at or below the programmed Under Voltage Cutoff threshold.
2,3	HPD	PWM output disabled.	Release throttle.	1. Applied throttle input >20% when KSI is turned on. 2. Applied throttle input >20% after clearing throttle fault.
2,4	Throttle Fault	Throttle request disabled.	Throttle input signal within allowable limits.	1. Throttle input wire open or shorted. 2. Defective throttle. 3. Wrong Throttle Type selected.
3,1	Coil Short/Driver Fault	PWM output and main contactor disabled.	Check the connections and replace the main contactor if necessary.	1. Main contactor coil is shorted. 2. Internal driver transistor is shorted.
3,2	Main Weld Fault	PWM output and main contactor disabled.	1. Replace main contactor. 2. Correct the parameter Rev Input/Main Driver.	1. Main contactor is welded. 2. Main contactor is controlled outside, but main driver function is active.
3,3	Main Driver Fault	PWM output and main contactor disabled.	Replace defective controller.	1. Main contactor driver is broken.
3,4	Main Contactor DNC	PWM output disabled.	Voltage difference between KSI and B+ busbar is less than the main contactor DNC threshold.	1. Main contactor did not close (DNC).
4,1	Under Voltage Cutback	Output current reduced.	Battery voltage rises above Under Voltage Cutback threshold.	1. Battery voltage at or below the programmed Undervoltage Cutback threshold. 2. Corroded battery terminal. 3. Loose battery or controller connection.
4,2	Over Voltage	PWM output disabled.	Battery voltage falls below (Over Voltage Cutoff - Over Voltage Hysteresis).	1. Battery voltage $\geq$ factory-set Over Voltage Cutoff threshold. 2. Operation with charger attached.



**Table 5 TROUBLESHOOTING CHART, continued**

LED CODE	PROGRAMMER LCD DISPLAY	EFFECT OF FAULT	RECOVERY	POSSIBLE CAUSE
4,3	Thermal Cutback	Output current reduced.	<ol style="list-style-type: none"> <li>1. Current reduced during overtemperature.</li> <li>2. Current reduced to 50% during undertemperature.</li> </ol>	<ol style="list-style-type: none"> <li>1. Temperature <math>\geq</math>Temp Cutback setpoint or <math>\leq -10^{\circ}\text{C}</math>.</li> <li>2. Excessive load on motor or controller.</li> <li>3. Improper mounting of controller.</li> <li>4. Operation in extreme environments.</li> <li>5. Controller thermistor damaged.</li> </ol>
4,4	Over Temperature	PWM output disabled.	Heatsink temperature $\leq 100^{\circ}\text{C}$ .	<ol style="list-style-type: none"> <li>1. Heatsink temperature exceeds the Temperature Cutoff threshold (<math>110^{\circ}\text{C}</math>).</li> </ol>

Note: Faults related to the main contactor (LED codes 3,1 / 3,2 / 3,3 / 3,4) are detected only when the main contactor is driven by the controller—wiring configuration shown in Figure 4, and Rev Input / Main Driver parameter = 2 (see page 24).

## 6

## MAINTENANCE

There are no user serviceable parts in Curtis 1204M/05M/09M/21M controllers. **No attempt should be made to open, repair, or otherwise modify the controller.** Doing so may damage the controller and will void the warranty.

It is recommended that the controller and connections be kept clean and dry and that the controller's fault history file be checked and cleared periodically.

## CLEANING

Periodically cleaning the controller exterior will help protect it against corrosion and possible electrical control problems created by dirt, grime, and chemicals that are part of the operating environment and that normally exist in battery powered systems.



**When working around any battery powered system, proper safety precautions should be taken.** These include, but are not limited to: proper training, wearing eye protection, and avoiding loose clothing and jewelry.

Use the following cleaning procedure for routine maintenance. Never use a high pressure washer to clean the controller.

1. Remove power by disconnecting the battery.
2. Discharge the capacitors in the controller by connecting a load (such as a contactor coil) across the controller's **B+** and **B-** terminals.
3. Remove any dirt or corrosion from the power and signal connector areas. The controller should be wiped clean with a moist rag. Dry it before reconnecting the battery.
4. Make sure the connections are tight.

## DIAGNOSTIC HISTORY

The Curtis programming devices can be used to access the controller's fault history file, via the Faults/Diagnostics menu. The programmer will read out all the faults the controller has experienced since the last time the fault history file was cleared. Faults such as contactor faults may be the result of loose wires; contactor wiring should be carefully checked. Faults such as overtemperature may be caused by operator habits or by overloading.

After a problem has been diagnosed and corrected, it is a good idea to clear the fault history file. This allows the controller to accumulate a new file of faults. By checking the new fault history file at a later date, you can readily determine whether the problem was indeed fixed.

## **APPENDIX A**

### **VEHICLE DESIGN CONSIDERATIONS REGARDING ELECTROMAGNETIC COMPATIBILITY (EMC) AND ELECTROSTATIC DISCHARGE (ESD)**

#### **ELECTROMAGNETIC COMPATIBILITY (EMC)**

Electromagnetic compatibility (EMC) encompasses two areas: emissions and immunity. *Emissions* are radio frequency (RF) energy generated by a product. This energy has the potential to interfere with communications systems such as radio, television, cellular phones, dispatching, aircraft, etc. *Immunity* is the ability of a product to operate normally in the presence of RF energy.

EMC is ultimately a system design issue. Part of the EMC performance is designed into or inherent in each component; another part is designed into or inherent in end product characteristics such as shielding, wiring, and layout; and, finally, a portion is a function of the interactions between all these parts. The design techniques presented below can enhance EMC performance in products that use Curtis motor controllers.

#### *Emissions*

Signals with high frequency content can produce significant emissions if connected to a large enough radiating area (created by long wires spaced far apart). Contactor drivers and the motor drive output from Curtis controllers can contribute to RF emissions. Both types of output are pulse width modulated square waves with fast rise and fall times that are rich in harmonics. (Note: contactor drivers that are not modulated will not contribute to emissions.) The impact of these switching waveforms can be minimized by making the wires from the controller to the contactor or motor as short as possible and by placing the wires near each other (bundle contactor wires with Coil Return; bundle motor wires separately).

For applications requiring very low emissions, the solution may involve enclosing the controller, interconnect wires, contactors, and motor together in one shielded box. Emissions can also couple to battery supply leads and throttle circuit wires outside the box, so ferrite beads near the controller may also be required on these unshielded wires in some applications. It is best to keep the noisy signals as far as possible from sensitive wires.

#### *Immunity*

Immunity to radiated electric fields can be improved either by reducing overall circuit sensitivity or by keeping undesired signals away from this circuitry. The controller circuitry itself cannot be made less sensitive, since it must accurately detect and process low level signals from sensors such as the throttle potentiometer. Thus immunity is generally achieved by preventing the external RF energy from coupling into sensitive circuitry. This RF energy can get into the controller circuitry via conducted paths and radiated paths.

Conducted paths are created by the wires connected to the controller. These wires act as antennas and the amount of RF energy coupled into them is generally proportional to their length. The RF voltages and currents induced in each wire are applied to the controller pin to which the wire is connected. Curtis controllers include bypass capacitors on the printed circuit board's throttle wires to reduce the impact of this RF energy on the internal circuitry. In some applications, additional filtering in the form of ferrite beads may also be required on various wires to achieve desired performance levels.

Radiated paths are created when the controller circuitry is immersed in an external field. This coupling can be reduced by placing the controller as far as possible from the noise source or by enclosing the controller in a metal box. Some Curtis controllers are enclosed by a heatsink that also provides shielding around the controller circuitry, while others are partially shielded or unshielded. In some applications, the vehicle designer will need to mount the controller within a shielded box on the end product. The box can be constructed of just about any metal, although steel and aluminum are most commonly used.

Most coated plastics do not provide good shielding because the coatings are not true metals, but rather a mixture of small metal particles in a non-conductive binder. These relatively isolated particles may appear to be good based on a dc resistance measurement but do not provide adequate electron mobility to yield good shielding effectiveness. Electroless plating of plastic will yield a true metal and can thus be effective as an RF shield, but it is usually more expensive than the coatings.

A contiguous metal enclosure without any holes or seams, known as a Faraday cage, provides the best shielding for the given material and frequency. When a hole or holes are added, RF currents flowing on the outside surface of the shield must take a longer path to get around the hole than if the surface was contiguous. As more "bending" is required of these currents, more energy is coupled to the inside surface, and thus the shielding effectiveness is reduced. The reduction in shielding is a function of the longest linear dimension of a hole rather than the area. This concept is often applied where ventilation is necessary, in which case many small holes are preferable to a few larger ones.

Applying this same concept to seams or joints between adjacent pieces or segments of a shielded enclosure, it is important to minimize the open length of these seams. Seam length is the distance between points where good ohmic contact is made. This contact can be provided by solder, welds, or pressure contact. If pressure contact is used, attention must be paid to the corrosion characteristics of the shield material and any corrosion-resistant processes applied to the base material. If the ohmic contact itself is not continuous, the shielding effectiveness can be maximized by making the joints between adjacent pieces overlapping rather than abutted.

The shielding effectiveness of an enclosure is further reduced when a wire passes through a hole in the enclosure; RF energy on the wire from an external field is re-radiated into the interior of the enclosure. This coupling mechanism can be reduced by filtering the wire where it passes through the shield boundary.

Given the safety considerations involved in connecting electrical components to the chassis or frame in battery powered vehicles, such filtering will usually consist of a series inductor (or ferrite bead) rather than a shunt capacitor. If a capacitor is used, it must have a voltage rating and leakage characteristics that will allow the end product to meet applicable safety regulations.

The B+ (and B-, if applicable) wires that supply power to a control panel should be bundled with the other control wires to the panel so that all these wires are routed together. If the wires to the control panel are routed separately, a larger loop area is formed. Larger loop areas produce more efficient antennas which will result in decreased immunity performance.

Keep all low power I/O separate from the motor and battery leads. When this is not possible, cross them at right angles.

## **ELECTROSTATIC DISCHARGE (ESD)**

Curtis motor controllers contain ESD-sensitive components, and it is therefore necessary to protect them from ESD (electrostatic discharge) damage. Most of these control lines have protection for moderate ESD events, but must be protected from damage if higher levels exist in a particular application.

ESD immunity is achieved either by providing sufficient distance between conductors and the ESD source so that a discharge will not occur, or by providing an intentional path for the discharge current such that the circuit is isolated from the electric and magnetic fields produced by the discharge. In general the guidelines presented above for increasing radiated immunity will also provide increased ESD immunity.

It is usually easier to prevent the discharge from occurring than to divert the current path. A fundamental technique for ESD prevention is to provide adequately thick insulation between all metal conductors and the outside environment so that the voltage gradient does not exceed the threshold required for a discharge to occur. If the current diversion approach is used, all exposed metal components must be grounded. The shielded enclosure, if properly grounded, can be used to divert the discharge current; it should be noted that the location of holes and seams can have a significant impact on ESD suppression. If the enclosure is not grounded, the path of the discharge current becomes more complex and less predictable, especially if holes and seams are involved. Some experimentation may be required to optimize the selection and placement of holes, wires, and grounding paths. Careful attention must be paid to the control panel design so that it can tolerate a static discharge.

MOV, transorbs, or other devices can be placed between B- and offending wires, plates, and touch points if ESD shock cannot be otherwise avoided.

## APPENDIX B

### PROGRAMMING DEVICES

Curtis programmers provide programming, diagnostic, and test capabilities for the 1204M/05M/09M/21M controllers. The power for operating the programmer is supplied by the host controller via a 4-pin connector. When the programmer powers up, it gathers information from the controller.

Two types of programming devices are available: the PC Programming Station and the handheld programmer. The Programming Station has the advantage of a large, easily read screen; on the other hand, the handheld programmer has the advantage of being more portable and hence convenient for making adjustments in the field.

Both programmers are available in User, Service, Dealer, and OEM versions. Each programmer can perform the actions available at its own level and the levels below that—a User-access programmer can operate at only the User level, whereas an OEM programmer has full access.

#### PC PROGRAMMING STATION (1314)

The Programming Station is an MS-Windows 32-bit application that runs on a standard Windows PC. Instructions for using the Programming Station are included with the software.

#### HANDHELD PROGRAMMER (1311, 1313)

The 1313 handheld programmer is functionally equivalent to the PC Programming Station. The 1311 is an earlier model with fewer functions. Instructions are provided in the 1311 and 1313 manuals.

#### PROGRAMMER FUNCTIONS

Programmer functions include:

**Parameter adjustment** — provides access to the individual programmable parameters.

**Monitoring** — presents real-time values during vehicle operation; these include all inputs and outputs.

**Diagnostics and troubleshooting** — presents diagnostic information, and also a means to clear the fault history file.

**Cloning** — allows you to copy customized parameter settings files.

**Programming** — allows you to update the system software (not available on the 1311).

**Favorites** — allows you to create shortcuts to your frequently-used adjustable parameters and monitor variables (not available on the 1311).



