



CURTIS

Manual

Models **1212** & **1212P**

Electronic Motor Controllers



Curtis Instruments, Inc.

200 Kisco Avenue

Mt. Kisco, NY 10549

www.curtisinstruments.com



Read Instructions Carefully!

Specifications are subject to change without notice.

© 2013 Curtis Instruments, Inc. ® Curtis is a registered trademark of Curtis Instruments, Inc.

© The design and appearance of the products depicted herein are the copyright of Curtis Instruments, Inc.

53112 Rev D 11/13

The Curtis Difference 
You feel it when you drive it

CONTENTS	
1. OVERVIEW.....	1
2. INSTALLATION AND WIRING	4
Mounting the Controller	4
Connections: High Current	5
Connections: Low Current	5
Controller Wiring: Standard Installation, 1212	6
Controller Wiring: Standard Installation, 1212P	7
Throttle Wiring	8
Switches and Other Hardware	10
3. PROGRAMMABLE PARAMETERS.....	13
Drive Parameters	15
Speed Parameters	17
Throttle Parameters.....	18
Current Parameters.....	21
Inhibit Parameters	21
Brake Parameters	22
Horn Parameters.....	22
Motor Parameters	23
BDI Parameters	24
Compensation Parameters	25
Emergency Reverse Parametes.....	26
Miscellaneous Parameters.....	27
4. MONITOR MENU	28
5. INITIAL SETUP	29
6. VEHICLE PERFORMANCE ADJUSTMENT	32
7. DIAGNOSTICS AND TROUBLESHOOTING.....	38
8. MAINTENANCE	42
APPENDIX A Vehicle Design Considerations	
APPENDIX B EN 13849 Compliance, 1212P Controller	
APPENDIX C Battery Discharge Indicator (BDI) Setup	
APPENDIX D Programming Devices	
APPENDIX E 1212/1212P Controller Specifications	

FIGURES

FIG. 1:	Curtis 1212/1212P electronic motor controllers.....	1
FIG. 2:	Mounting dimensions, Curtis 1212/1212P controllers	4
FIG. 3a:	Standard wiring configuration, 1212 controller	6
FIG. 3b:	Standard wiring configuration, 1212P controller	7
FIG. 4:	Wiring for 5k Ω , 3-wire potentiometer	8
FIG. 5:	Wiring for voltage throttle.....	8
FIG. 6:	Wiring to inhibit operation during battery charging	11
FIG. 7:	Effect of adjusting the Throttle Map parameter	19
FIG. 8:	Wiring for brake light.....	22
FIG. 9:	Wiring for Pump SRO	27
FIG. B-1:	Safety channel block diagram	B-1

TABLES

TABLE 1:	Programmable parameter menus	13
TABLE 2:	Status LED fault codes	39
TABLE 3:	Troubleshooting chart	40
TABLE E-1:	Specifications, 1212/1212P controllers	E-1

1

OVERVIEW

The Curtis 1212 and 1212P motor speed controllers provide precise and smooth control of permanent magnet drive motors for battery powered vehicles. The 1212 is designed for use in low power DME applications such as micro-scooters, mini-scooters, foldable scooters, and low-end personal mobility vehicles. Although it is optimized for use on modern 3-wheel and 4-wheel mobility aid scooters, its programmable options also allow it to be used on any low power permanent magnet motor application. The 1212P is designed for use in pallet truck applications.

The 1212/1212P controllers are fully programmable by means of a Curtis programming device. Use of the programmer offers diagnostic and test capability as well as configuration flexibility.

Fig. 1 *Curtis 1212/1212P electronic motor controller.*



Like all Curtis motor controllers, the 1212 and 1212P offer superior operator control of the vehicle's motor drive speed. **Key features** include:

Smooth and Secure Control

- ✓ Advanced speed regulation maintains precise speed over varied terrain, obstacles, curbs, and ramps
- ✓ Linear cutback of current ensures smooth control, with no sudden loss of power during undervoltage or overtemperature
- ✓ Optional speed limit potentiometer provides direct and linear control of the maximum vehicle speed
- ✓ Proprietary algorithms help prevent gearbox wear while providing smooth starts and reversals

More Features 

- ✓ The vehicle is brought to a complete stop before the electromagnetic brake is applied, ensuring safe and secure stops under all conditions
- ✓ Charger inhibit input prevents driving while charger is attached
- ✓ Key Off Decel function ensures a smooth “brake to stop” when the key is turned off while driving or when a fault occurs that requires the vehicle to stop
- ✓ Anti-Rollback/Roll-forward function provides smooth and safe vehicle control on hills and ramps
- ✓ Internal main contactor provides secure power-off
- ✓ Boost current gives a brief boost of current greatly improving transient loads such as starting on a hill, crossing thresholds, etc.

Easy Installation and Setup

- ✓ Industry standard footprint, mounting centers, and wiring allows drop-in replacement of other controllers
- ✓ 1212 and 1212P controllers are easily programmed with a Curtis programming device, or can be supplied pre-programmed
- ✓ Accepts all standard throttle types, including single-ended, wigwag, and unipolar
- ✓ Simplified troubleshooting and diagnostics
- ✓ Standard Mini-Fit Molex Jr. and Faston terminals provide proven, robust wiring connections

Valuable Additional Features

- ✓ Optional Push Switch input releases the brake and allows the motor to free-wheel (1212 models only)
- ✓ Push-Too-Fast feature restricts the vehicle’s speed while it is being pushed, even with the key off or the batteries disconnected
- ✓ Automatic compensation for changes in motor condition to ensure optimum drive performance at all times
- ✓ Multi-mode provides for two distinct and programmable control modes (indoor/outdoor)
- ✓ Power Saver function prevents the controller draining the battery when the vehicle is inactive
- ✓ Battery Discharge Indicator output
- ✓ Optional Speed Inhibit input offers flexibility to reduce speed or prevent drive under certain conditions, such as when the seat is lifted
- ✓ Adjustable brake hold voltage reduces heating of the brake coil
- ✓ Reverse Beeper function alerts bystanders
- ✓ Electronics sealed to IPX5

Robust Safety and Reliability

- ✓ High RF immunity prevents speed variation and shutdowns in noisy RF environments
- ✓ Controller power circuits and microprocessor software are continuously monitored for proper operation
- ✓ On power-up, system automatically checks the throttle, brake, and associated wiring, and disables drive if a fault is found

Meets or Complies with Relevant US and International regulations

- ✓ 1212 is designed to meet EN 12184, EN 55022, IEC 61000-6-2 & -4-6, and ISO 7176; FDA documentation filed; TÜV certification pending.
- ✓ 1212P designed to meet EN 12895, EN 1175, EN 13849, and UL583.

Unique features of 1212P for pallet truck applications

- ✓ Emergency reverse with belly button switch input
- ✓ Emergency stop provides immediate EM braking
- ✓ Input from Curtis 906 battery discharge indicator meter
- ✓ Output Lift Lockout signal, which can drive a relay
- ✓ Neutral input that can be used to shut off output regardless of throttle input

Note: Push feature is not available with the 1212P.

Familiarity with your Curtis controller will help you install and operate it properly. We encourage you to read this manual carefully. If you have questions, please contact the Curtis office nearest you.

Working on electric vehicles is potentially dangerous. You should protect yourself against runaways and high current arcs:

RUNAWAYS — Some conditions could cause the vehicle to run out of control. Disconnect the motor or jack up the vehicle and get the drive wheels off the ground before attempting any work on the motor control circuitry.

HIGH CURRENT ARCS — Always open the battery circuit before working on the motor control circuit. Wear safety glasses, and use properly insulated tools to prevent shorts.

2

INSTALLATION AND WIRING

MOUNTING THE CONTROLLER

The 1212/1212P controller can be oriented in any position, but **the location should be carefully chosen to keep the controller clean and dry. If a clean, dry mounting location cannot be found, a cover must be used to shield the controller from water and contaminants.**

The outline and mounting hole dimensions are shown in Figure 2. The controller should be mounted by means of the two mounting holes at the opposing corners of the heatsink, using M4 (#8) screws.

Fig. 2 *Mounting dimensions, Curtis 1212 and 1212P controllers.*

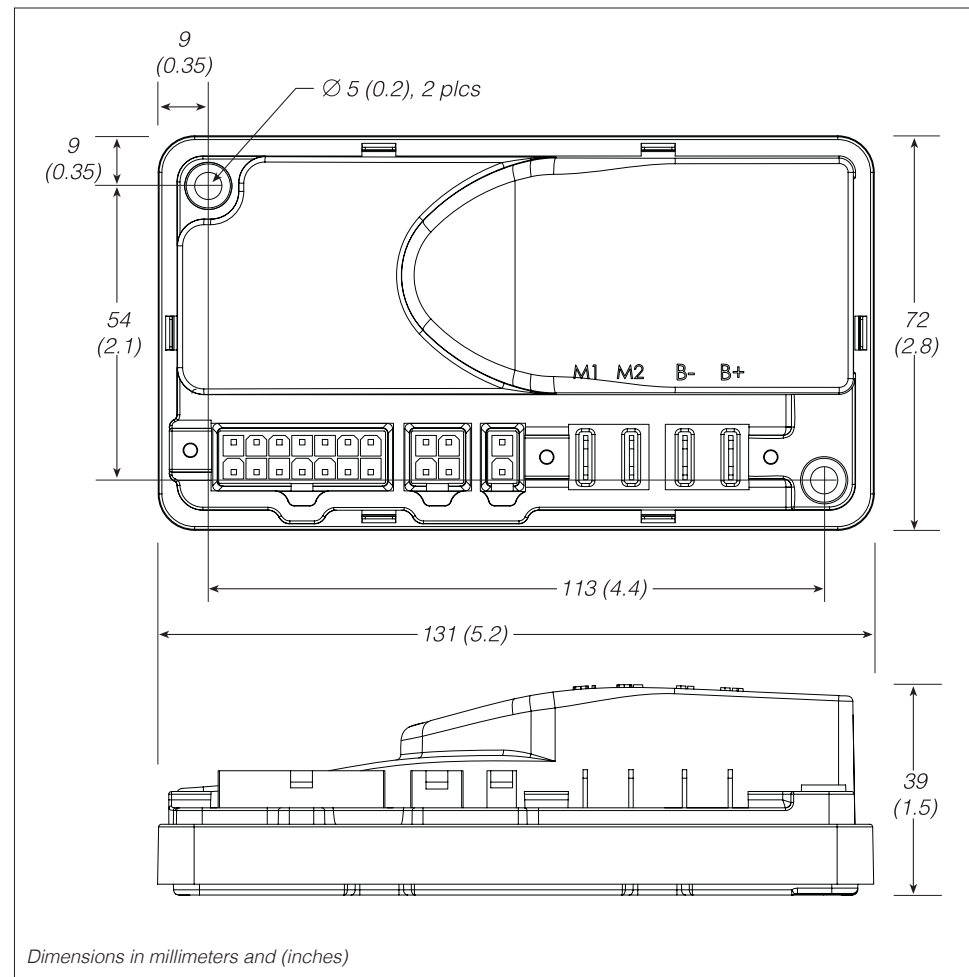

You will need to take steps during the design and development of your end product to ensure that its EMC performance complies with applicable regulations; suggestions are presented in Appendix A.

CONNECTIONS: High Current

Four 1/4" Faston terminals are provided for the high current connections. The motor connections (**M1**, **M2**) and battery connections (**B+**, **B-**) have one terminal each.

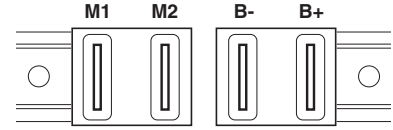

CONNECTIONS: Low Current

The low current logic control connections are provided by a 14-pin connector. The mating connector is a Molex Mini-Fit-Jr. receptacle p/n 39-01-2140 with appropriate 45750-series crimp terminals.

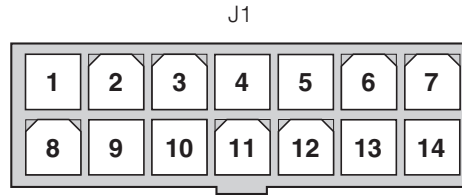

- J1 Pin 1 pot wiper
- J1 Pin 2 pot high
- J1 Pin 3 horn / lift lockout output*
- J1 Pin 4 mode switch (open=M1, closed=M2)
- J1 Pin 5 keyswitch input (KSI)
- J1 Pin 6 speed inhibit
- J1 Pin 7 B+

- J1 Pin 8 pot low
- J1 Pin 9 speed pot / pump SRO input* / lift lockout input*
- J1 Pin 10 status LED
- J1 Pin 11 BDI
- J1 Pin 12 reverse switch / neutral input*
- J1 Pin 13 B-
- J1 Pin 14 push switch / emergency reverse*

**Lift lockout, emergency reverse, pump SRO, and neutral input available only on 1212P.*

- J2 Pin 1 Rx
- J2 Pin 2 B-
- J2 Pin 3 Tx/charge inhibit
- J2 Pin 4 B+

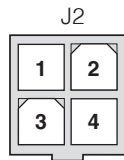

A 4-pin low power connector is provided for the programmer and the battery charger. The mating connector is a Molex Mini-Fit-Jr. receptacle p/n 39-01-2040 with appropriate 45750-series crimp terminals. (A mating connector is provided with the handheld programmer.)

- J3 Pin 1 Brake +
- J3 Pin 2 Brake -



A 2-pin low power connector is provided for the electromagnetic brake. The mating connector is a Molex Mini-Fit-Jr. receptacle p/n 39-01-2020 with appropriate 45750-series crimp terminals.

WIRING: STANDARD INSTALLATION, 1212

The wiring diagram presented in Figure 3a shows a typical installation for a DME application. This installation is shown with a single-ended 3-wire 5kΩ potentiometer throttle and a reverse switch. With wigwag throttles, a reverse switch is not used and Pin J1-12 is left unconnected.

The optional speed inhibit input can be wired into the circuit in various ways; in the standard installation shown here, it is B- active (Inhibit Type parameter set to 0).

The J2 connector can be used interchangeably for the programmer or for the battery charger.

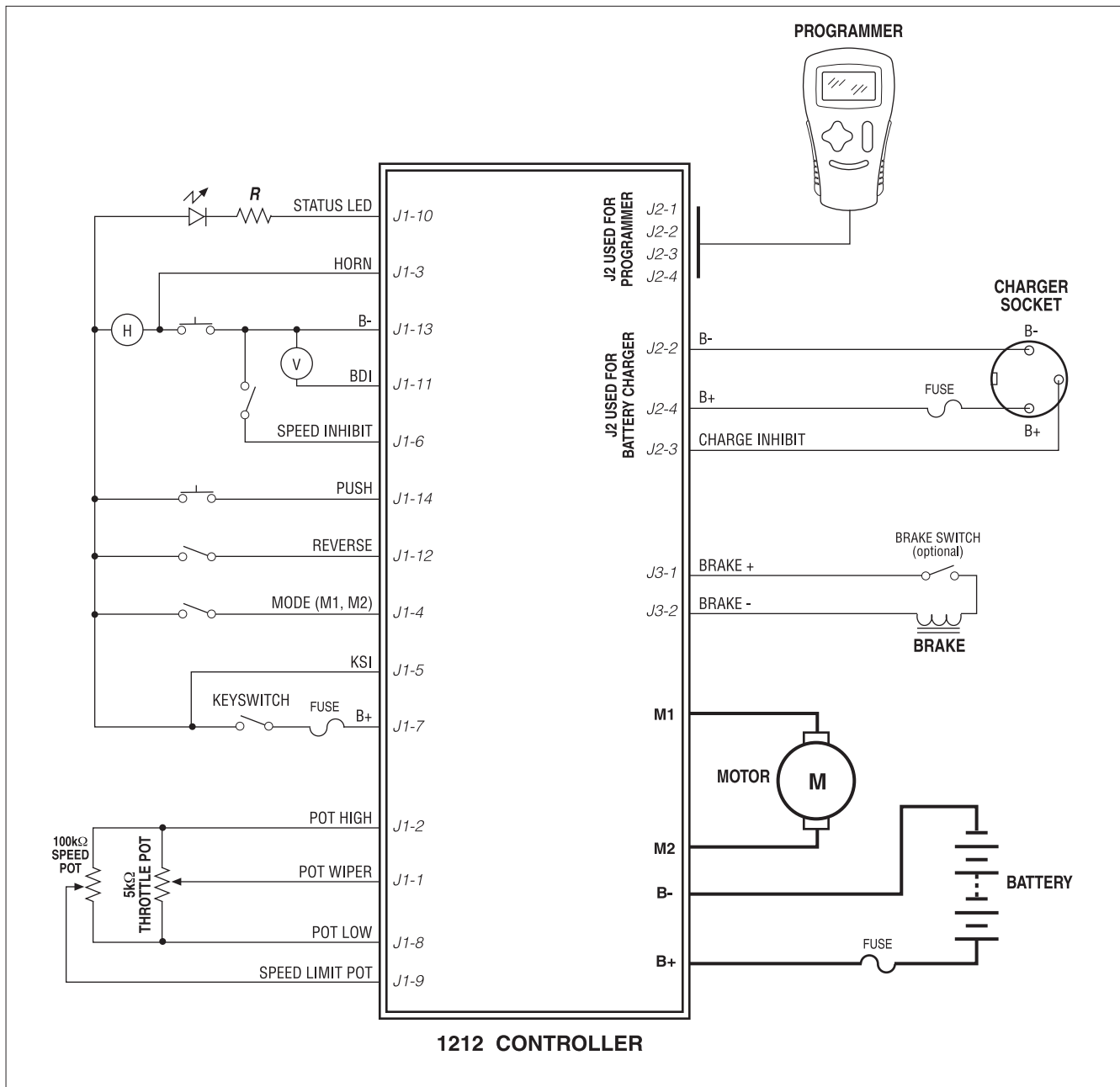

Fig. 3a Standard wiring configuration, Curtis 1212 controller.

WIRING: STANDARD INSTALLATION, 1212P

The wiring diagram presented in Figure 3b shows a typical installation for a pallet truck application. This installation is shown with a Curtis ET-190 MCU electronic throttle. The inhibit input can be wired into the circuit in various ways; in the standard installation shown here it serves as an interlock (see pin J1-6), and is B+ inactive (Inhibit Type parameter set to 4).

The J2 connector can be used interchangeably for the programmer or for the battery charger.

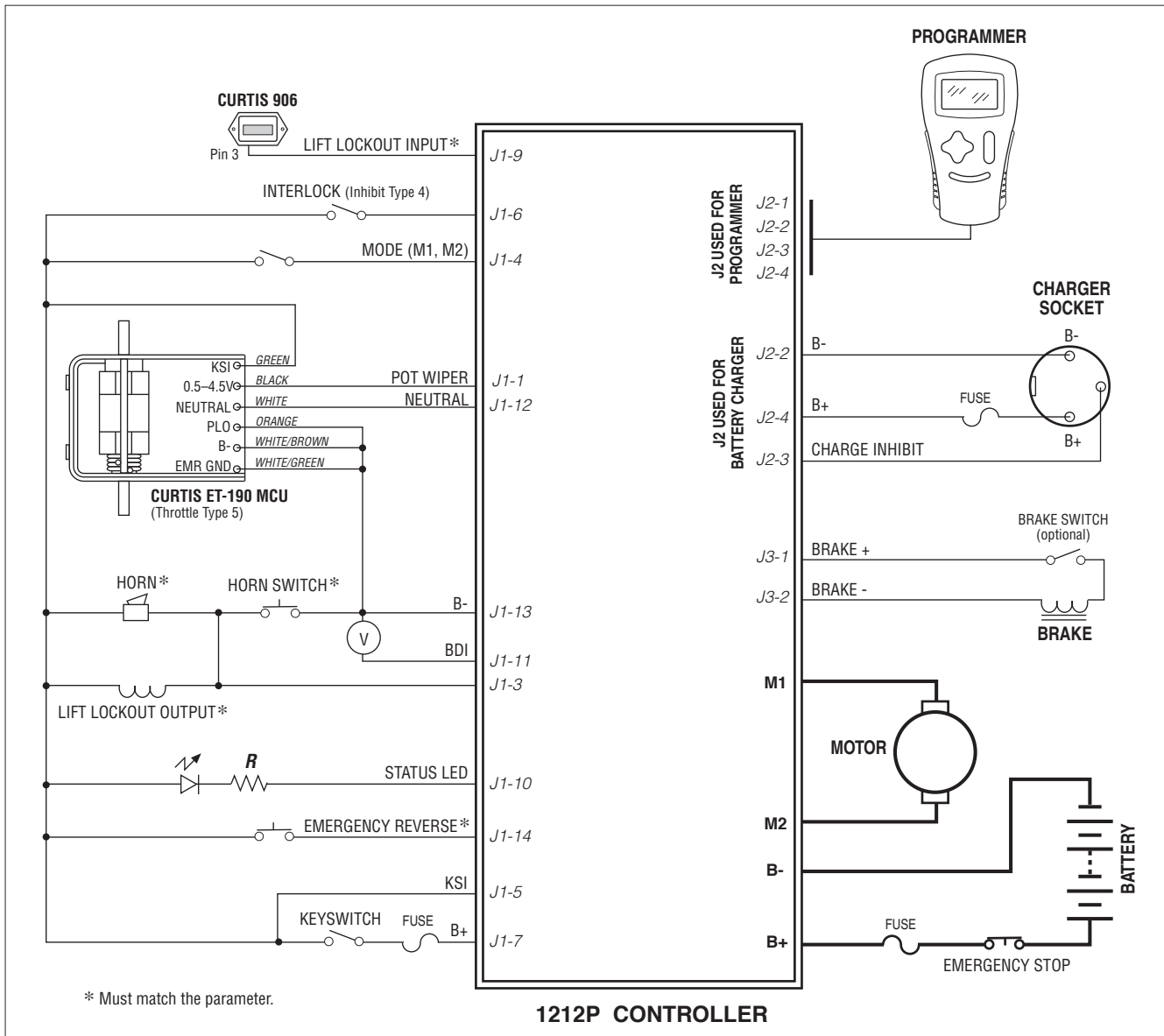

Fig. 3b Standard wiring configuration, Curtis 1212P controller.



The polarity of the motor **M1** and **M2** connections will affect the operation of the emergency reverse feature. The forward and reverse switches and the **M1** and **M2** connections must be configured so that the vehicle drives away from the operator when the emergency reverse button is pressed.

THROTTLE WIRING

Either a 3-wire potentiometer throttle or a voltage throttle can be used with the 1212/1212P controller. The controller can accept a single-ended, inverse single-ended, wigwag, inverse wigwag, or unipolar input signal from the throttle, depending on how the Throttle Type parameter is programmed; see page 18.

Throttle wiring is described in the following text. If the throttle you are planning to use is not covered, contact the Curtis office nearest you.

5k Ω , 3-Wire Potentiometer

A 5k Ω , 3-wire potentiometer is shown in the wiring diagrams (Figures 3a and 3b) as well as in Figure 4. With this throttle, the controller can be programmed for a Throttle Type 0–4 input signal; see page 18.

Fig. 4 *Wiring for 3-wire, 5k Ω potentiometer throttle.*

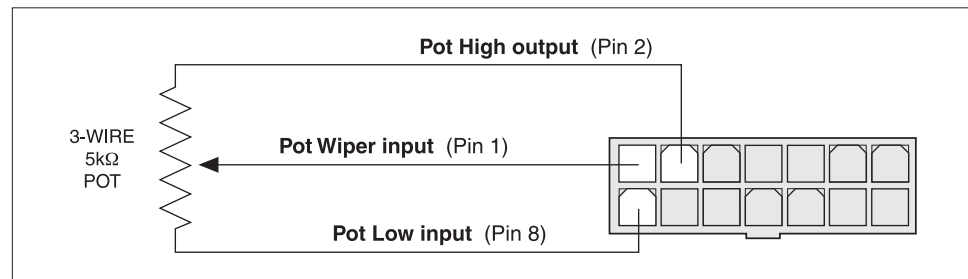

For wigwag, inverted wigwag, and unipolar applications, the pot can be correctly centered within the controller's neutral band by using the throttle autocalibration feature (see page 20).

The controller provides full pot fault protection against open or shorted wires anywhere in the throttle assembly. The overall pot resistance should be 5k Ω \pm 20%. Values outside this range will trigger a fault condition. If a pot fault occurs while the vehicle is moving, the controller will decelerate the vehicle to a smooth stop using the decel rate set by the Key Off Decel parameter. If the fault is corrected while the throttle is still applied, an HPD fault will be issued and driving is disabled until throttle is reduced to neutral.

Voltage Throttle

Wiring for a voltage throttle is shown in Figure 5. With this throttle, the controller can be programmed for a Throttle Type 5–9 input signal; see page 18.

Fig. 5 *Wiring for voltage throttle.*

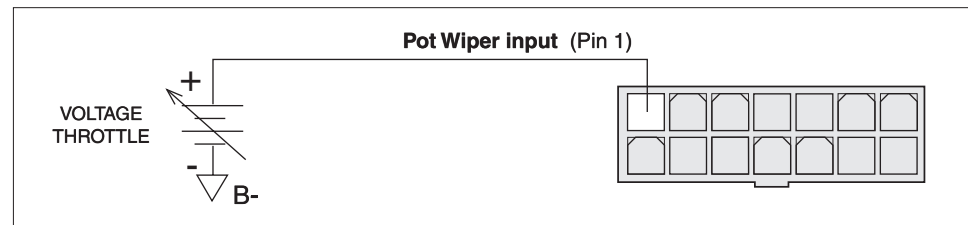

The PotHigh and PotLow parameters are used to set the voltage range of these throttles. If the pot wiper voltage is higher than the programmed PotHigh

value or lower than the programmed PotLow value, the controller will issue an out-of-range throttle fault. In order for the controller to be able to detect out-of-range throttle faults, the throttle must have a range within the limits of 0.4–4.6 V.

Note: If a 0–5V throttle is used, it is the responsibility of the OEM to provide appropriate throttle fault detection.

Speed Limit Pot / Lift Lockout Input

A speed limit pot allows the operator to adjust the speed of the vehicle at full throttle. The speed limit pot should be sized so that it does not affect throttle input resistance and thus the throttle response; a 100k Ω pot is recommended.

The speed limit pot is at its maximum speed setting when its wiper is shorted to the throttle's pot high connection (Pin 2). When the speed limit pot is in its maximum speed position, the vehicle's speed at full throttle corresponds to the programmed maximum speed setting.

The speed limit pot is at its minimum speed setting when its wiper is shorted to the throttle's pot low connection (Pin 8). When the speed limit pot is in its minimum speed position, the vehicle's speed at full throttle corresponds to the programmed minimum speed setting. For information on the programmable speed parameters, see Section 3.

The speed limit pot varies the vehicle's speed linearly over the range between the minimum and maximum speed settings in each mode, in forward and in reverse.

If a speed limit pot is not used, the Speed Limit Pot parameter should be programmed Off to disable the fault check at the speed limit pot.

In 1212P models only, the same pin (Pin 9) can also take an external lift lockout signal from a Curtis 906 meter to control the lift lockout driver when lift lockout is triggered. This feature inhibits the speed limit pot input.

SWITCHES AND OTHER HARDWARE

Keyswitch

The vehicle should have a master on/off switch to turn the system off when not in use. The keyswitch provides logic power for the controller and for the other control input switches. It must be sized to carry the 150 mA quiescent logic current plus the current necessary to drive the precharge function (1.5 A for 0.5 seconds) and the status LED, horn, and any other accessories powered from the keyswitch circuit.

Push Switch / Emergency Reverse Switch

A push switch can be used to electrically release the electromagnetic brake and inhibit driving. Maximum speed in push mode is set by the Push Max Speed parameter. If a push input is applied at power-up, it will not be acknowledged until it has been released and reapplied. The vehicle can enter push mode only when it is in neutral or when the controller is not powered on.

In 1212P models only, this input (Pin 14) can be used for an emergency reverse switch (belly button switch); see parameter Switch Normally Closed, on page 26. When the vehicle moves forward or stops, if the emergency reverse switch is pressed the vehicle will decelerate to a stop (if it was moving) and then be driven in the reverse direction.

Brake Release Switch (Brake Coil Disable Switch)

If a brake release lever is used to release the electromagnetic brake mechanically, a brake coil disable switch is recommended. This switch opens the electromagnetic brake coil circuit when the mechanical brake release lever releases the brake from the motor shaft. The open brake coil circuit will register as a fault, inhibiting controller operation if an operator attempts to drive the vehicle with the brake mechanically released. This safety feature ensures that the vehicle cannot be driven when the brake cannot be engaged.

Mode Switch

A mode switch is used to select operation in Mode 1 or Mode 2. Typically, Mode 1 is programmed for slower indoor driving and Mode 2 for faster outdoor driving; see Speed menu. The controller is in Mode 2 when the mode switch is in the On position (input connected to B+). Leaving the mode input floating or actively switching it Off (pulling it to B-) puts the controller in Mode 1.

Emergency Stop Switch

This switch is used only in 1212P applications, and is shown in the wiring diagram (Figure 3b, page 7). When the emergency stop button is pressed, the controller shuts off the EM brake output regardless of vehicle speed, thus engaging the brake immediately.

Battery Discharge Indicator (BDI)

The 1212/1212P controller can drive a BDI panel meter to show the battery pack's state of charge as a percentage of the ampere-hour capacity of the bat-

teries. The batteries must be put through a full charge cycle with the controller installed before the BDI will begin operation.

Charger Inhibit

Typically, battery chargers have a dedicated third terminal that automatically provides inhibit. When the charger is connected to the controller's J2 connector, the controller disables the drive functions and engages the EM brake while the charger is connected. Inhibit is provided through J2 Pin 3; see wiring diagrams (Figure 3a, page 6, and Figure 3b, page 7). The charger inhibit automatically powers up the controller without the keyswitch on so that BDI can be tracked during charge. After BDI is 100% reset, power is totally shut off (no current used) to avoid draining the battery.

If your battery charger does not have a dedicated inhibit terminal, you **must** wire B- to J2 Pin 3, as shown in Figure 6.

Fig. 6 *Wiring to inhibit operation during battery charging (for battery chargers without a dedicated inhibit terminal).*

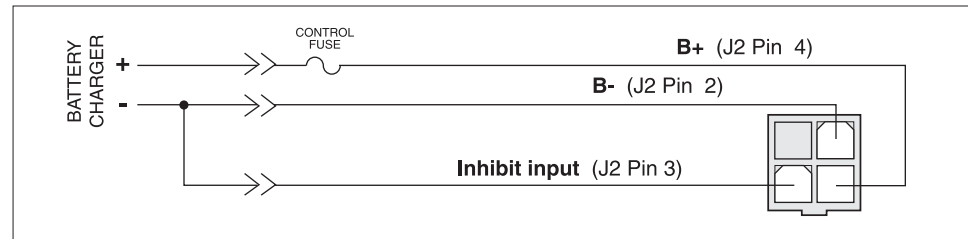

Speed Inhibit

A speed inhibit switch can be used to limit drive speed, or even to prevent drive altogether, in certain conditions; see Inhibit menu. The maximum speed allowed during inhibit operation is also set in the Inhibit menu, with a setting of zero preventing drive.

Circuitry Protection Devices

To protect the control wiring from accidental shorts, a low current fuse (appropriately sized for the maximum control circuit current draw) should be connected in series with the B+ logic supply. A fuse is also recommended in the high power circuit from the battery to the controller's B+ terminal. This fuse will protect the power system from external shorts and should be sized appropriately for the maximum rated current of the controller.

Status LED

The 1212/1212P controller has the capability to drive a panel indicator LED, which can be used to tell the operator, at a glance, the controller's status. This LED always indicates whether the controller is powered on or off. It will also provide diagnostics information via flash codes (see Section 7).

If a status LED is used, it should be installed with the proper resistor in series. The controller's LED driver is capable of a maximum current of 15 mA. The recommended resistor—designed to limit driver current to 15 mA when active—is 2.4 k Ω , 0.5 W. Alternatively, an LED with a built-in resistor can be used; it should be rated for 24V operation.

Horn / Lift Lockout Output

The controller's horn driver—Pin 3—is designed to drive a low current dc horn at 1 Hz. The horn sounds a warning when the reverse direction is selected and when the throttle autocalibration feature is being used. The horn driver sinks a maximum current of 15 mA. Using a horn with a higher current requirement will damage and disable the driver. The horn driver can be used to drive a brake light instead of a horn; see Brake menu.

In 1212P models only, Pin 3 can be used to drive a relay to control the pump contactor. Setting the parameter Lift Lockout Enable = On will enable this feature and disable the horn output. Also, if the parameter External Lift Lockout = On, the lift lockout output will be active if the lift lockout input is low. The maximum current for this low-side driver is 50 mA.

Reverse Switch / Neutral Input

If a single-ended or unipolar throttle is used, a reverse switch connected to B+ can be used to change the driving direction to reverse.

In 1212P models only, this input (Pin 12) can be used for a neutral input. When the parameter Neutral Input = On, the 1212P will check this input from a wigwag throttle that has neutral output (such as the Curtis ET-190 MCU). If the neutral input is low, the 1212P will shut off output regardless of throttle input.

3

PROGRAMMABLE PARAMETERS

The 1212/1212P controllers have a number of parameters that can be programmed using a Curtis handheld programmer or Curtis PC Programming Station. These programmable parameters allow the vehicle's performance to be customized to best fit the needs of individual vehicle operators.

For information on programming devices, see Appendix D.

For information on how to use the parameters to optimize performance, see Section 6.

The programmable parameters are grouped hierarchically into menus, as shown in Table 1. Not all of these parameters are displayed on all controllers; the list for any given controller depends on its specifications.

Table 1 Programmable Parameter Menus: 1311 Programmer

<p>DRIVE MENU p. 15</p> <ul style="list-style-type: none"> —Accel Max Speed —Accel Min Speed —Decel High Speed —Decel Low Speed —Rev Accel Max Speed —Rev Accel Min Speed —Rev Decel High Speed —Rev Decel Low Speed —Key Off Decel —E Stop Decel —E Stop Pause —Soft Start —Gear Soften —Creep Speed —Push Max Speed —Soft Stop Speed —Speed p. 17 <ul style="list-style-type: none"> —Mode 1 <ul style="list-style-type: none"> —Max Speed —Min Speed —Rev Max Speed —Rev Min Speed —Mode 2 <ul style="list-style-type: none"> —Max Speed —Min Speed —Rev Max Speed —Rev Min Speed 	<p>THROTTLE MENUp. 18</p> <ul style="list-style-type: none"> —Type —Neutral Input —PotHigh —PotLow —Neutral Deadband —Throttle Max —HPD —Speed Limit Pot —Throttle Map —Tremor Suppression —Calibration 	<p>BRAKE MENU p. 22</p> <ul style="list-style-type: none"> —Delay —Fault Check —Hold Voltage —Brake Light
	<p>CURRENT MENU p. 21</p> <ul style="list-style-type: none"> —Main Current Limit —Braking Current Limit —Boost Current —Boost Time 	<p>HORN MENU p. 22</p> <ul style="list-style-type: none"> —Fault Beep —Reverse Beep —Beep Constant
	<p>INHIBIT MENU p. 21</p> <ul style="list-style-type: none"> —Type —Speed 	<p>MOTOR MENU p. 23</p> <ul style="list-style-type: none"> —System Resistance —Resistance Auto Comp —Auto Comp Current Limit —Speed Scaler —Current Rating —Max Current Time —Cutback Gain —Stall p. 23 <ul style="list-style-type: none"> —Stall Speed —Stall PWM —Stall Timeout

Table 1 Programmable Parameter Menus: 1311 Programmer, cont'd

BDI MENU p. 24
— Full Voltage
— Empty Voltage
— Full Charge Voltage
— Start Charge Voltage
— Reset Voltage
— Low BDI Level
— Low BDI Max Speed
— Charge Factor
— Discharge Factor
— External Lift Lockout
— Lift Lockout Enable
— Lift Lockout Threshold
— Lift Lockout Output Type

EMERGENCY REVERSE MENU p. 26
— Speed
— Time Limit
— Decel Rate
— Accel Rate
— Max Braking Current
— Switch Normally Closed
— EMR Interlock

MISCELLANEOUS MENU p. 27
— Sleep
— Reset Drive Time
— Emergency Stop
— Pump SRO

COMPENSATION MENU p. 25
— IR Comp
— Anti-Rollback Comp

DRIVE MENU		
PARAMETER	ALLOWABLE RANGE	DESCRIPTION
Accel Max Speed	0.2–8.0 s	Sets the rate (in seconds) at which the speed command increases when throttle is applied with the speed limit pot is in its maximum speed position, and the vehicle is traveling forward. Larger values represent slower response. Note: Allowable range is restricted by the Accel Min Speed setting.
Accel Min Speed	0.2–8.0 s	Sets the rate (in seconds) at which the speed command increases when throttle is applied while the speed limit pot is in its minimum speed position, and the vehicle is traveling forward. Larger values represent slower response Note: Allowable range is restricted by the Accel Max Speed setting.
Decel High Speed	0.2–8.0 s	Sets the rate (in seconds) that is used to slow down the vehicle when it is traveling forward at high speed and throttle is reduced. Larger values represent slower response. Note: Allowable range is restricted by the Decel Low Speed setting.
Decel Low Speed	0.2–8.0 s	Sets the rate (in seconds) that is used to slow down the vehicle when it is traveling forward at low speed and throttle is reduced. Larger values represent slower response. Note: Allowable range is restricted by the Decel High Speed setting.
Rev Accel Max Speed	0.2–8.0 s	Sets the rate (in seconds) at which the speed command increases when throttle is applied while the speed limit pot is in its maximum speed position, and the vehicle is traveling in reverse. Larger values represent slower response. Note: Allowable range is restricted by Rev Accel Min Speed setting.
Rev Accel Min Speed	0.2–8.0 s	Sets the rate (in seconds) at which the speed command increases when throttle is applied while the speed limit pot is in its minimum speed position, and the vehicle is traveling in reverse. Larger values represent slower response. Note: Allowable range is restricted by Rev Accel Max Speed setting.
Rev Decel High Speed	0.2–8.0 s	Sets the rate (in seconds) that is used to slow down the vehicle when it is traveling in reverse at high speed and throttle is reduced. Larger values represent slower response. Note: Allowable range is restricted by Rev Decel Low Speed setting.
Rev Decel Low Speed	0.2–8.0 s	Sets the rate (in seconds) that is used to slow down the vehicle when it is traveling in reverse at low speed and throttle is reduced. Larger values represent slower response. Note: Allowable range is restricted by Rev Decel High Speed setting.
Key Off Decel	0.2–4.0 s	Sets the rate (in seconds) that is used to slow down the vehicle at key-off or in the event of a major fault.

DRIVE MENU, cont'd		
PARAMETER	ALLOWABLE RANGE	DESCRIPTION
E Stop Decel	0.2–4.0 s	Sets the rate (in seconds) that is used to slow down the vehicle during emergency reverse, i.e., when a throttle command >80% in the reverse direction is given while the vehicle is moving forward. This gives the operator a way to stop more quickly when unexpected conditions arise.
E Stop Pause	0.0–1.0 s	Sets a pause before reversing direction after an emergency reverse stop. This gives the operator time to return the throttle to neutral without moving backwards.
Soft Start	0–100 %	This parameter can be used to soften the bump associated with gear slack in the transaxle when throttle is applied from the neutral state. Larger values provide a softer slack take-up.
Gear Soften	0–100 %	This parameter is intended to soften the bump associated with gear slack in the transaxle when throttle is released and then reapplied while the vehicle is still moving. Larger values provide a softer slack take-up.
Creep Speed	0–10 %	Creep Speed helps to prevent vehicle rollback on inclines when the brake is released with very little throttle applied. It is activated when the throttle request exceeds the throttle deadband threshold.
Push Max Speed	25–50 %	<i>Available only with 1212.</i> Sets the maximum speed at which the vehicle can be pushed. When the vehicle is powered on and in neutral, it enters the push mode when the push button is activated. The electromagnetic brake is released, driving is inhibited, and speed is limited to Push Max Speed. When the vehicle is not powered on and the brake is mechanically released to enable pushing, Push Max Speed still applies. Once sufficient voltage is generated by the motor, speed will be limited by the controller.
Soft Stop Speed	0–30 %	Sets the speed at which a gentler deceleration is initiated when the throttle is released to neutral; larger values start the soft stop deceleration sooner.

SPEED MODES

The 1212/1212P controller's Multi-Mode™ feature allows operation in two distinct modes: Mode 1 and Mode 2. These modes can be programmed to provide two different sets of operating characteristics, which can be useful for operation in different conditions. For example, Mode 1 could be programmed such that the vehicle moves slowly for precise, indoor maneuvering, and Mode 2 programmed for higher speed, long distance travel outdoors.

The controller is in Mode 2 when the mode switch is in the On position (input connected to B+). Leaving the mode input floating or actively switching it Off (pulling it to B-) puts the controller in Mode 1.

The **Speed** menu allows the maximum speed in forward and reverse to be set independently in Mode 1 and Mode 2. The position of the speed limit pot determines whether the programmed Max Speed or Min Speed—or a speed between these two programmed speeds—is in effect. Speed is varied linearly over the range between the two speeds in each mode, in forward and reverse.

SPEED MENU		
PARAMETER	ALLOWABLE RANGE	DESCRIPTION
M1/M2 Max Speed	0–100 %	During forward operation, defines the requested speed at full throttle when the speed limit pot is in its maximum speed position. Note: Allowable range is restricted by the M1/M2 Min Speed setting.
M1/M2 Min Speed	0–100 %	During forward operation, defines the requested speed command at full throttle when the speed limit pot is in its minimum speed position. Min Speed cannot be set higher than the programmed Max Speed. Note: Allowable range is restricted by the M1/M2 Max Speed setting. Note: For this parameter to apply, a speed limit pot must be installed in parallel with the throttle and the Speed Limit Pot parameter must be programmed On (see Throttle menu).
M1/M2 Rev Max Speed	0–100 %	During reverse operation, defines the requested speed at full throttle when the speed limit pot is in its maximum speed position. Note: Allowable range is restricted by M1/M2 Rev Min Speed setting.
M1/M2 Rev Min Speed	0–100 %	During reverse operation, defines the requested speed command at full throttle when the speed limit pot is in its minimum speed position. Rev Min Speed cannot be set higher than the programmed Rev Max Speed. Note: Allowable range is restricted by M1/M2 Rev Max Speed setting. Note: For this parameter to apply, a speed limit pot must be installed in parallel with the throttle and the Speed Limit Pot parameter must be programmed On (see Throttle menu).

THROTTLE MENU		
PARAMETER	ALLOWABLE RANGE	DESCRIPTION
Type	0–9	<p>The 1212/1212P controller can accept inputs from both 5kΩ, 3-wire pot throttles and voltage throttles. Set the throttle type parameter to match the throttle used in your application.</p> <p><i>5kΩ, 3-wire pot throttles</i></p> <ul style="list-style-type: none"> 0 = wigwag 1 = inverted wigwag 2 = single-ended; neutral when wiper at PotLow 3 = inverted single-ended; neutral when wiper at PotHigh 4 = unipolar. <p><i>Voltage throttles</i></p> <ul style="list-style-type: none"> 5 = wigwag 6 = inverted wigwag 7 = single-ended; neutral when wiper \leq PotLow 8 = inverted single-ended voltage; neutral when wiper \geq PotHigh 9 = unipolar <p>Note: If Throttle Type 5–9 is used, see note on page 9.</p>
Neutral Input	On/Off	<p><i>Available only with 1212P.</i></p> <p>When programmed On, enables neutral input detection.</p>
PotHigh	3–5 V	<p>Sets the maximum voltage for voltage throttles (Types 5–9). (For 5kΩ, 3-wire pot throttles, PotHigh is determined by the throttle itself.)</p>
PotLow	0–2 V	<p>Sets the minimum voltage for voltage throttles (Types 5–9). (For 5kΩ, 3-wire pot throttles, PotLow is determined by the throttle itself.)</p>
Neutral Deadband	5–30 %	<p>Sets the throttle range the controller interprets as neutral. Increasing the parameter setting increases the neutral range. This parameter allows the neutral deadband to be defined wide enough to ensure the controller goes into neutral when the throttle is released.</p> <p>Guidelines for adjusting this parameter are provided in Section 5.</p>
Throttle Max	40–100 %	<p>Sets the pot wiper voltage required to produce 100% controller output. Increasing the Throttle Max setting reduces the wiper voltage required, and therefore reduces the stroke necessary to produce full output. This feature allows reduced-range throttle assemblies to be used.</p> <p>Guidelines for setting Throttle Max are provided in Section 5.</p>
HPD	On/Off	<p>When programmed On, vehicle drive is inhibited if a throttle command outside the neutral deadband is issued before the controller is powered up. Drive will continue to be inhibited until the throttle is returned to within the neutral deadband. If the HPD fault is not cleared within 10 seconds, a wiring fault is declared and a power cycle is required.</p>
Speed Limit Pot	On/Off	<p>This parameter is used to enable/disable the speed limit pot. If no speed limit pot is used, set Speed Limit Pot to Off.</p>

THROTTLE MENU, cont'd		
PARAMETER	ALLOWABLE RANGE	DESCRIPTION
Throttle Map	20–80 %	<p>The throttle map parameter adjusts the static throttle map. The parameter setting corresponds to the throttle command at half throttle, as shown in Figure 7.</p> <p>A setting of 50% provides linear response. Values below 50% reduce the throttle command at low throttle positions, providing enhanced slow speed maneuverability. Values above 50% give the vehicle a faster, more responsive feel at low throttle positions.</p>
Tremor Suppression	0–100 %	<p>This parameter can be used to limit the controller's response to sharp throttle movements, such as movements resulting from hand tremors.</p> <p>Larger values will provide a steadier ride, but they also result in more sluggish response to throttle request. There is thus a trade-off between crispness of response (low Tremor Suppression settings) and steady speed in the presence of tremors (high settings).</p>

Fig. 7 Effect of throttle adjustment parameters. These four parameters determine the controller's response to throttle position, in forward and reverse.

Here,

Deadband = 10%
 Throttle Max = 90%
 Creep = 0%.

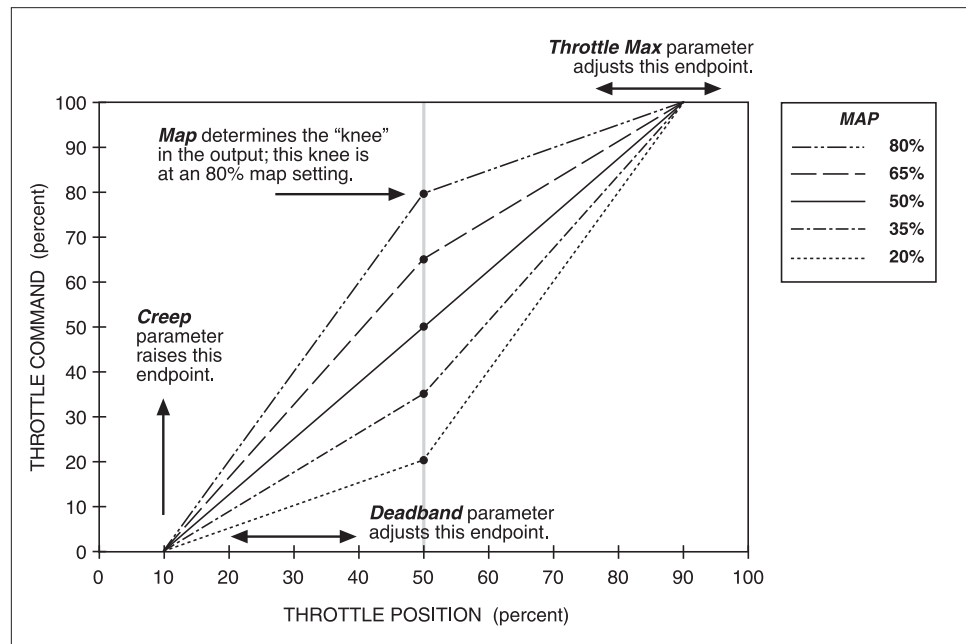

THROTTLE MENU, cont'd		
PARAMETER	ALLOWABLE RANGE	DESCRIPTION
Calibration	On/Off	<p>Wigwag and unipolar throttle pots should be centered. Setting this parameter to On inhibits driving and puts the controller into throttle autocalibration mode; see procedure below.</p> <p>Setting the parameter Off returns the controller to normal operation.</p>

CALIBRATION OF WIGWAG AND UNIPOLAR THROTTLE POTS

The Calibration parameter provides a means of easily and reliably centering wigwag and unipolar throttle pots. A horn must be connected to the horn driver during the procedure. The controller inhibits driving while in calibration mode, enabling the throttle pot to be adjusted safely.

1. Jack the vehicle drive wheels off the ground or disconnect the motor leads.
2. Completely assemble the throttle mechanism but do not tighten the clamping mechanism that secures the potentiometer shaft to the throttle lever.
3. Plug the programmer into the controller, and turn the keyswitch on.
4. Select the program mode and scroll down to the throttle autocalibration parameter.
5. Set the Calibration parameter On (Program » Throttle » Calibration). At this point, the horn will probably sound, indicating that the throttle pot is out of adjustment. If the horn does not sound, the pot is already centered and no further adjustment is necessary.
6. With the throttle lever at the neutral position, adjust the potentiometer in one direction until the horn turns off. Note this position. Adjust the pot in the other direction until the horn turns off. Note this position. Set the pot halfway between the two noted positions. The pot is now adjusted to the proper value for neutral.
7. Tighten the clamping mechanism that secures the throttle lever to the potentiometer shaft. Depress and release the throttle to verify the mechanical return to neutral; the horn should turn off with the same amount of motion in both directions.
8. Set the calibration parameter Off, or cycle the keyswitch to reset it to Off. (If you are performing the reset by cycling the keyswitch, note that KSI must remain off for at least 4 seconds.) The vehicle will not drive if the throttle autocalibration parameter is left On.

CURRENT MENU		
PARAMETER	ALLOWABLE RANGE	DESCRIPTION
Main Current Limit	<i>model dependant</i>	<p>Sets the maximum current the controller will supply to the motor during normal driving. By limiting the current supplied, this parameter can be used to protect the motor from potentially damaging currents or to reduce the maximum torque applied to the drive system.</p> <p>For 1212-22xx controllers, it is adjustable from 10 to 45 amperes. For 1212-24xx controllers, it is adjustable from 15 to 70 amperes. For 1212P controllers, it is adjustable from 15 to 90 amperes.</p>
Braking Current Limit	<i>model dependant</i>	<p>Sets the maximum current the controller will supply to the motor during braking. By limiting the current supplied, this parameter can be used to protect the motor from potentially damaging currents or to reduce the maximum braking torque applied to the drive system.</p> <p>For 1212-22xx controllers, it is adjustable from 10 to 45 amperes. For 1212-24xx controllers, it is adjustable from 15 to 70 amperes. For 1212P controllers, it is adjustable from 15 to 90 amperes.</p>
Boost Current	<i>model dependant</i>	<p>Boost current gives a brief boost of current that greatly improves performance with transient loads, such as starting on a hill, crossing a threshold, climbing obstacles, etc. When the controller recognizes that the motor needs more current to respond to a drive request, it provides a current boost of a set amount for a set time.</p> <p>The Boost Current parameter defines the motor current limit during the boost period.</p> <p>For 1212-22xx controllers, it is adjustable from 10 to 55 amperes. For 1212-24xx controllers, it is adjustable from 15 to 80 amperes. For 1212P controllers, it is adjustable from 15 to 90 amperes.</p>
Boost Time	0–10 s	This parameter sets the maximum time that the boost current is allowed.

INHIBIT MENU		
PARAMETER	ALLOWABLE RANGE	DESCRIPTION
Type	0–5	<p>The flexible speed input at J1 Pin 6 can be used to limit or to inhibit speed under certain conditions. For example, a switch could be installed under the seat so that if the operator drives the scooter while they are standing the max speed will be limited.</p> <p>The Inhibit Type parameter is used to select how the inhibit function will be implemented. Depending on how the inhibit switch is wired into the system, set this parameter to:</p> <ul style="list-style-type: none"> 0 = B- active 1 = B+ active 2 = Open circuit active 3 = B- inactive 4 = B+ inactive 5 = Open circuit inactive.
Speed	0–100 %	This parameter limits the maximum speed allowed during speed inhibit mode. A setting of 0 prevents drive during inhibit mode.

BRAKE MENU		
PARAMETER	ALLOWABLE RANGE	DESCRIPTION
Delay	0–1 s	Sets the length of delay between when zero speed is commanded and the electromagnetic brake is engaged.
Fault Check	On/Off	Enables/disables the fault detection on the EM brake.
Hold Voltage	10–24 V	A high initial voltage is applied to the brake coil when the brake is first released. After approximately 1 second, this peak voltage drops to the programmed Hold Voltage. The parameter should be set high enough to hold the brake released under all the shock and vibration conditions the vehicle will be subjected to.
Brake Light	On/Off	<p>When set to On, the horn output (J1 Pin 3) will act as a brake light driver. The brake light must be driven by a relay, as shown in Figure 8. The brake light will be turned on when the throttle is returned to neutral and will remain on for about 2 seconds after the EM brake is engaged.</p> <p>When the horn output is used as a brake light driver, Fault Beep (see Horn menu) should be programmed Off.</p> <p>When Brake Light is set to Off, the horn output acts as a horn driver.</p>

Fig. 8 *Wiring for brake light.*

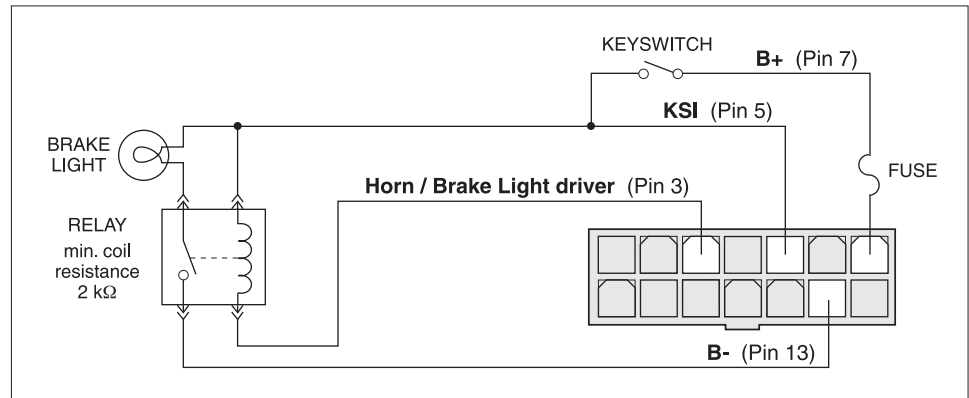

HORN MENU		
PARAMETER	ALLOWABLE RANGE	DESCRIPTION
Fault Beep	On/Off	When programmed On, the horn will be used to provide audible fault codes whenever faults are present. These are the same fault codes that are flashed by the status LED. If a fault should occur while the vehicle is driving in reverse with the reverse beep active, the fault signal will take precedence. If this audible fault alarm is not wanted, set Fault Beep to Off.
Reverse Beep	On/Off	When programmed On, the horn will sound whenever the vehicle is being driven in reverse. On vehicles with reverse switches, the horn will sound when the reverse switch is activated.
Beep Constant	On/Off	Sets the reverse beep to be a constant tone (when programmed On) or a 1Hz pulse (when programmed Off).

MOTOR MENU		
PARAMETER	ALLOWABLE RANGE	DESCRIPTION
System Resistance	0–800 m Ω	Sets the system resistance (motor + brushes + wiring + connections) used for load compensation and speed estimation. Control system performance depends on this parameter being set correctly; it must be set to the actual cold motor resistance. For instructions, see initial setup procedure ④, on page 29.
Resistance Auto Comp	On/Off	Resistance is automatically measured under a preset low current before the brake is released. The measured motor resistance plays an important role in IR compensation. The Resistance Auto Comp parameter enables/disables this automatic function.
Auto Comp Current Limit	5–50 %	Sets the current limit used for automatic resistance testing, as a percentage of the Main Current Limit (see Current menu).
Speed Scaler	20–27 V	The Speed Scaler parameter sets the maximum voltage that can be applied to the motor. It can be used to eliminate variations in maximum speed that would otherwise result when driving with a fully charged battery vs. a partially discharged battery. If Speed Scaler is set to 23 volts, for example, the maximum vehicle speed will be the same whether the actual battery voltage is 27 volts or 23 volts or any value in between.
Current Rating	<i>model dependent</i>	This parameter should be set to the current rating provided by the motor manufacturer. For 1212-22xx controllers, it is adjustable from 0 to 45 amperes. For 1212-24xx controllers, it is adjustable from 0 to 70 amperes. For 1212P-25xx controllers, it is adjustable from 0 to 35 amperes.
Max Current Time	0–120 s	Sets the maximum amount of time the motor is allowed to run at the main current limit.
Cutback Gain	0–100 %	When the motor overheats, the drive current is cut back until it reaches the programmed Current Rating. The Cutback Gain determines how quickly this cutback will occur, once the programmed Max Current Time has expired.

STALL MENU		
PARAMETER	ALLOWABLE RANGE	DESCRIPTION
Stall Speed	0–255	<i>1212 only.</i> Sets the Stall Speed that will be used to determine a Motor Stalled fault. A Motor Stalled fault is issued when the estimated speed < Stall Speed and the duty cycle is < Stall PWM for longer than Stall Timeout.
Stall PWM	0–100 %	<i>1212 only.</i> Sets the Stall PWM that will be used to determine a Motor Stalled fault; see description in Stall Speed parameter description.
Stall Timeout	16–32 s	<i>1212 only.</i> Sets the Stall Timeout that will be used to determine a Motor Stalled fault; see description in Stall Speed parameter description.

The **Battery** menu allows any lead acid battery to be installed and the BDI algorithm tailored to match it. Actual usage duty cycle greatly affects the settings and the overall accuracy of the BDI algorithm. The power level and type of battery charger used also affect the BDI algorithm, and therefore testing must be done to match the charger as well.

See Appendix C for guidelines on setting up these BDI parameters.

BDI MENU		
PARAMETER	ALLOWABLE RANGE	DESCRIPTION
Full Voltage	20.0–28.0 V	Voltage when the battery is fully charged. Note: Allowable range is restricted by the Empty Voltage, Start Charge Voltage, and Reset Voltage settings.
Empty Voltage	16.0–24.0 V	Voltage when the battery is fully discharged. Note: Allowable range is restricted by the Full Voltage setting.
Full Charge Voltage	24.0–32.0 V	Voltage, when a charger is connected, above which the battery is considered finished charging. Note: Allowable range is restricted by the Start Charge setting.
Start Charge Voltage	21.0–29.0 V	Voltage above which the battery is considered to start charging. Note: Allowable range is restricted by the Full Voltage and Full Charge Voltage settings.
Reset Voltage	20.0–28.0 V	Voltage at which the BDI calculator will be reset to 100%, after the charger is disconnected and the controller is powered up. Note: Allowable range is restricted by the Full Voltage setting.
Discharge Factor	0.1–10.0	Discharge rate of the battery. Larger values are for larger batteries, which discharge more slowly.
Charge Factor	0.1–10.0	Charge rate of the battery. Larger values are for larger batteries, which charge more slowly.
Low BDI Level	0–100 %	Sets the battery charge level at which maximum vehicle speed will be limited in order to protect the battery from deep discharge. Setting Low BDI Level to zero disables this function and allows the battery to discharge completely.
Low BDI Max Speed	10–100 %	Sets the maximum allowed vehicle speed when the battery charge falls below the programmed Low BDI Level.
External Lift Lockout	On/Off	<i>Available only with 1212P.</i> When programmed On, the lift lockout input (pin 9) activates the lift lockout feature. When programmed Off, the lift lockout feature is activated by the controller's internal BDI.

BDI MENU, cont'd

PARAMETER	ALLOWABLE RANGE	DESCRIPTION
Lift Lockout Enable	On/Off	<i>Available only with 1212P.</i> When programmed On, the lift lockout output is enabled and the horn output is disabled. The output can be used to drive a relay to control a pump contactor. When programmed Off, the lift lockout feature is disabled and the horn output is enabled.
Lift Lockout Threshold	0–50 %	<i>Available only with 1212P.</i> Sets the lift lockout BDI threshold when External Lift Lockout = Off. The lift lockout output will be active when the BDI falls below the programmed threshold.
Lift Lockout Output Type	0–1	<i>Available only with 1212P.</i> When set to 0, the output will be pulled low when active. When set to 1, the output will be open circuit when active.

COMPENSATION MENU

PARAMETER	ALLOWABLE RANGE	DESCRIPTION
IR Comp	0–100 %	Sets the motor load compensation. Higher values provide stronger disturbance rejection, while lower values provide smoother operation. Note: Allowable range is restricted by the Anti-Rollback Comp setting.
Anti-Rollback Comp	0–125 %	Sets the motor load compensation after the throttle is released to neutral and the speed is estimated to be near zero. Higher values provide more hill-holding force. Note: Allowable range is restricted by the IR Comp setting.

EMERGENCY REVERSE MENU <i>Available only with 1212P</i>		
PARAMETER	ALLOWABLE RANGE	DESCRIPTION
Speed	10–100 %	Defines the maximum reverse speed of the motor when emergency reverse is active.
Time Limit	0–10 s	Defines how long emergency reverse is allowed to be active after the vehicle is moving in reverse direction. Setting this parameter to zero means there is no time limit.
Decel Rate	0.2–4.0 s	Sets the rate at which the vehicle brakes to a stop when emergency reverse is activated and the vehicle is moving forward. If the vehicle is already moving in the reverse direction above the programmed EMR speed, it will be brought down to the EMR speed.
Accel Rate	0.2–8.0 s	Sets the rate at which the vehicle scelerates in the reverse direction when emergency reverse is activated. speed.
Max Braking Current	15–90 A	Defines the maximum allowed motor current when the vehicle brakes to a stop when emergency reverse is activated.
Switch Normally Closed	On/Off	Defines the emergency reverse switch (belly button switch) type. On = BB switch is normally closed when it is not pressed. Off = BB switch is normally open when it is not pressed.
EMR Interlock	On/Off	Enables the emergency reverse interlock feature. On = the controller forces the throttle command to zero after emergency reverse is activated until the interlock switch is cycled. Off = this feature is not enabled.

MISCELLANEOUS MENU															
PARAMETER	ALLOWABLE RANGE	DESCRIPTION													
Sleep	0–60 minutes	Sets the delay time between the last throttle request or serial communication and when the controller goes into sleep mode. Setting the delay to zero disables the sleep function.													
Reset Drive Time	On/Off	The controller’s hourmeter logs the total drive time since the last reset; this record is accessible through the Monitor menu. Setting this parameter On zeroes the hourmeter and starts a new log; this is typically done when the vehicle is serviced. Reset Drive Time is automatically set to Off after the hourmeter is reset.													
Emergency Stop	On/Off	<p><i>Available only with 1212P.</i></p> <p>Defines how the vehicle will respond when the emergency stop button is pressed.</p> <p>On = The EM brake will be engaged rapidly when the emergency stop button is pressed; the battery is disconnected and the vehicle will stop abruptly.</p> <p>Off = When the emergency stop button is pressed, the battery is disconnected and the vehicle will decelerate for a short distance before it fully stops.</p>													
Pump SRO	On/Off	<p><i>Available only with 1212P.</i></p> <p>Pin J1-9 can be used to check the status of lift/lower switches that are wired to KSI; if these switches are closed before KSI is turned on, the controller will issue a Pump SRO Fault. Wiring is shown in Figure 9.</p> <p>To enable this feature, set the Pump SRO parameter On.</p> <p>The Lift Lockout Output is affected by both the External Lift Lockout parameter (see BDI menu) and the Pump SRO parameter as follows.</p> <table border="1" data-bbox="652 1205 1448 1442"> <thead> <tr> <th colspan="2">PARAMETER SETTINGS</th> <th rowspan="2">LIFT LOCKOUT OUTPUT TRIGGERED BY</th> </tr> <tr> <th>PUMP SRO</th> <th>EXTERNAL LIFT LOCKOUT</th> </tr> </thead> <tbody> <tr> <td>ON</td> <td>—</td> <td>Pump SRO Fault or Internal BDI</td> </tr> <tr> <td rowspan="2">Off</td> <td>ON</td> <td>Lift Lockout input from 906</td> </tr> <tr> <td>Off</td> <td>Internal BDI</td> </tr> </tbody> </table>	PARAMETER SETTINGS		LIFT LOCKOUT OUTPUT TRIGGERED BY	PUMP SRO	EXTERNAL LIFT LOCKOUT	ON	—	Pump SRO Fault or Internal BDI	Off	ON	Lift Lockout input from 906	Off	Internal BDI
PARAMETER SETTINGS		LIFT LOCKOUT OUTPUT TRIGGERED BY													
PUMP SRO	EXTERNAL LIFT LOCKOUT														
ON	—	Pump SRO Fault or Internal BDI													
Off	ON	Lift Lockout input from 906													
	Off	Internal BDI													

Fig. 9 *Wiring for Pump SRO.*

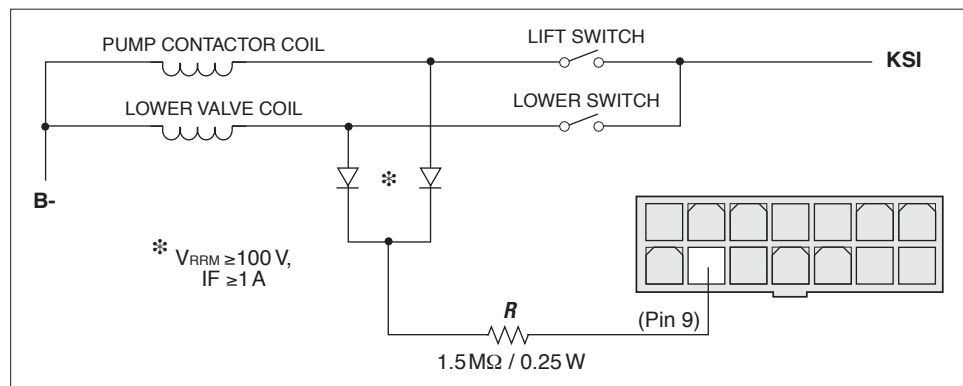

4

MONITOR MENU

Through its Monitor menu, the 1311 programmer provides access to real-time data during vehicle operation. This information is helpful during diagnostics and troubleshooting, and also while adjusting programmable parameters.

MONITOR MENU		
VARIABLE	DISPLAY RANGE	DESCRIPTION
Temp	-55 – +127 °C	Controller's internal temperature.
Battery Voltage	0–38.2 V	Battery voltage.
Motor Voltage	-27.4 – +27.4 V	Voltage drop between the motor terminals.
Motor Thermal Cutback	0–100 %	Current cutback during motor over-temperature, as a percentage of max current. 100% = no cutback.
Armature Current	-90 – +90 A	Measured motor armature current.
Current Limit	0–90 A	Ultimate current limit of the controller, taking into account boost mode, thermal protection, etc.
Resistance	0–854 mΩ	Measured system resistance, when the motor is stalled.
Throttle	0–100 %	Available throttle input.
Speed Limit Pot	0–100 %	Available speed limit pot input.
Mode Input	On/Off	Status of the mode switch (at J1-4).
Reverse Input	On/Off	Status of the reverse switch (at J1-12).
Inhibit	On/Off	Status of the speed inhibit switch (at J1-6).
EMR Input	On/Off	Status of the emergency reverse switch (belly button switch).
Push Input	On/Off	Status of the push switch (at J1-14).
Main Contactor	On/Off	Status of the main contactor driver.
Brake	On/Off	Status of the EM brake driver.
BDI	0–100 %	Status of battery capacity.
Drive Time	0–65535 hours	Hours of operation since the hourmeter was last reset (Reset Drive Time = On).

5

INITIAL SETUP

Before operating the vehicle, carefully complete the following initial setup procedures. If you find a problem during the checkout, refer to the diagnostics and troubleshooting section (Section 7) for further information.

Before starting the setup procedures, **jack the vehicle drive wheels up off the ground so that they spin freely**. Doublecheck all wiring to ensure that it is consistent with the wiring guidelines presented in Section 2. Make sure all connections are tight.

① Begin the setup procedures

①-a. Put the throttle in neutral, and open the forward/reverse switches.

①-b. Turn on the controller and plug in the programming device. The programmer should power up with an initial display, and the status LED should light steadily. If neither happens, check for continuity in the keyswitch circuit and controller ground.

② Throttle

Set the Throttle Type parameter (Program » Throttle » Type) to match the throttle you are using; see page 18.

It is important to ensure that the controller output is operating over its full range. The following tuning procedures will establish the Neutral Deadband and Throttle Max parameter values that correspond to the absolute full range of your particular throttle mechanism.* It is advisable to include some buffer around the absolute full range of the throttle mechanism to allow for throttle resistance variations over time and temperature as well as variations in the tolerance of potentiometer values between individual throttle mechanisms.

Tuning the Neutral Deadband

Starting with the Neutral Deadband set to its default value, adjust this parameter if necessary to provide a good balance. The deadband should be wide enough for the throttle to reliably return to neutral when released, yet without an excessive amount of travel in the “dead” zone before power is applied.

②-a. If the throttle travels too far when starting out of neutral before the brake disengages, decrease the Neutral Deadband value. If the brake sometimes doesn't engage when the throttle is returned to neutral, increase the Neutral Deadband value. The default setting of 10% should work for most applications.

②-b. If a wigwag or unipolar throttle assembly is being used, the procedure should be repeated for the reverse direction. The Neutral Deadband value should be set such that the throttle operates correctly in both forward and reverse.

* If you are using a wigwag or unipolar throttle, you should center it before proceeding with the throttle tuning procedures. Instructions for centering, using the Throttle Calibration parameter, are presented on page 20.

Tuning the Throttle Max

②-c. Apply full throttle and observe the Throttle value. This value should be 100%. If it is less than 100%, the Throttle Max value should be decreased to get 100% throttle. After entering a smaller Throttle Max value (Program » Throttle » Throttle Max), return to the Monitor menu and repeat this step until the Throttle % value is 100% at maximum throttle position.

②-d. Now that the full throttle position results in a 100% value for Throttle, slowly reduce throttle until the Throttle value drops below 100% and note the throttle position. This represents the extra range of motion allowed by the throttle mechanism. If this range is large, you may wish to decrease it by increasing Throttle Max. Entering a larger Throttle Max value (Program » Throttle » Throttle Max) will provide a larger active throttle range and more vehicle control. Return to the Monitor menu and repeat this step until an appropriate amount of extra range is attained.

②-e. If a wigwag or unipolar throttle is being used, repeat the procedure for the reverse direction. Throttle Max should be set such that the throttle operates correctly in both forward and reverse.

Confirming proper throttle operation

Select a direction and operate the throttle. The motor should begin to turn in the selected direction. If it does not, verify the wiring to the throttle and motor. The motor should run proportionally faster with increasing throttle. If not, refer to Section 7.



1212P models: The polarity of the motor's **M1** and **M2** connections will affect the operation of the emergency reverse feature. The forward and reverse switches and the **M1** and **M2** connections must be configured so that the vehicle drives away from the operator when the emergency reverse button (the belly button switch) is pressed.

③ Basic vehicle checkout

Using the Monitor menu, observe the status of each of the switches included in your application: mode, reverse, push, speed inhibit, emergency reverse. Cycle each input in turn, observing the programmer. The programmer should display the correct status for each input.

Similarly, check the throttle and speed limit pot inputs. The correct value for each input should be displayed.

Verify that all options, such as HPD, are as desired.

To verify the status of the charger inhibit input, plug in the charger and apply the throttle; the motor should not run.

If everything checks out, lower the vehicle drive wheels onto the ground.

④ Setting system resistance

It is very important that the System Resistance parameter be set accurately. This procedure must be conducted quickly and with the motor cold. If the

procedure needs to be repeated, ample time must be allowed for the motor to cool completely. Conducting the procedure with a warm motor will lead to erroneous settings.

The correct System Resistance value is determined as follows.

④-a. Position the vehicle up against a wall, high curb, or some other immovable object.

④-b. Plug in the programmer and turn the keyswitch on.

④-c. Set the Main Current Limit parameter (Program » Current » Main Current Limit) to 25 amps (1212-22xx models) or to 35 amps (1212-24xx and 1212P models).

④-d. Set the Boost Current Limit parameter (Program » Current » Boost Current Limit) to the same value as the Main Current Limit: 25 amps for 1212-22xx models, and 35 amps for 1212-24xx and 1212P models.

④-e. In the Monitor menu, scroll down to the Resistance field.

④-f. With the speed limit pot set at maximum, apply the throttle full forward, driving the vehicle against the immovable object.

④-g. Observe the Resistance value displayed in the Monitor menu.

④-h. Repeat steps ④-f and ④-g three more times. Do these measurements quickly, to minimize motor heating, and note all four Resistance values.

④-i. Program the System Resistance parameter (Program » Motor » System Resistance) to the average of the four Resistance values that were displayed in the Monitor menu.

④-j. Before moving on to Section 6, Vehicle Performance Adjustment, be sure to set the Main Current Limit and Boost Current Limit back to their default settings.

6

VEHICLE PERFORMANCE ADJUSTMENT

The 1212/1212P controller's adjustable parameters allow many aspects of vehicle performance to be optimized. Once a vehicle/motor/controller combination has been tuned, the parameter values can be made standard for that system or vehicle model. Any changes in the motor, the vehicle drive system, or the controller will require that the system be tuned again to provide optimum performance.

The tuning procedures should be conducted in the sequence given, because successive steps build upon the ones before. It is important that the effect of these programmable parameters be understood in order to take full advantage of the controller's features. Please refer to the descriptions of the applicable parameters in Section 3 if there is any question about what any of them do.

Instructions are provided for the following four tuning steps.

- ⑤ **Setting the maximum speeds**
- ⑥ **Setting the acceleration and deceleration rates**
- ⑦ **Adjusting load compensation**
- ⑧ **Fine-tuning the vehicle's response smoothness.**

⑤ Setting the maximum speeds

The four maximum speeds with the speed limit pot in its maximum speed position are set by the four Max Speed parameters:

M1/M2 Max Speed and M1/M2 Rev Max Speed.

The four maximum speeds with the speed limit pot in its minimum speed position are set by the four Min Speed parameters:

M1/M2 Min Speed and M1/M2 Rev Min Speed.

Each of the maximum speeds is programmed as a percentage of the maximum possible speed. Set each of the eight maximum speed parameters to give the desired performance.

⑥ Setting the acceleration and deceleration rates

The acceleration and deceleration functions have been designed to provide smooth throttle response when maneuvering at low speeds and snappy throttle response when traveling at high speeds. This is accomplished by defining acceleration/deceleration rates at each end of the speed limit pot's range. The rates are scaled linearly between these two endpoints. Four pairs of parameters define the endpoints of the acceleration/deceleration curves:

- Forward acceleration: Accel Min Speed — Accel Max Speed
- Forward deceleration: Decel Low Speed — Decel High Speed
- Reverse acceleration: Rev Accel Min Speed — Rev Accel Max Speed
- Reverse deceleration: Rev Decel Low Speed — Rev Decel High Speed.

The programmed acceleration and deceleration rates are independent of mode. However, it makes sense to adjust the low speed rates under the slowest speed conditions (Mode 1) and the high speed rates under the fastest speed conditions (Mode 2). Tuning the rates under the most extreme (slowest, fastest) conditions will most likely result in good performance throughout the entire driving range.

Note: Smaller values provide faster response.

Forward acceleration and deceleration rates

- ⑥-a. First, adjust Accel Min Speed. Select Mode 1 and set the speed limit pot to its minimum speed position. For low speed testing, we suggest that you drive in a confined area such as an office, where low speed maneuverability is crucial. Depending on how you liked the forward acceleration you experienced, increase or decrease the Accel Min Speed value. Continue testing and adjusting this value until you are satisfied with the vehicle's low speed forward acceleration.
- ⑥-b. Now adjust Decel Low Speed. Driving at full throttle with the speed limit pot still in its minimum speed position, release the throttle to neutral. Depending on how you liked the deceleration you experienced, increase or decrease the Decel Low Speed value. Continue testing and adjusting this value until you are satisfied with the vehicle's low speed forward deceleration.
- ⑥-c. Next, adjust Accel Max Speed. Select Mode 2 and set the speed limit pot to its maximum speed position. Apply full throttle. Depending on how you liked the forward acceleration you experienced, increase or decrease the Accel Max Speed value. Continue testing and adjusting this value until you are satisfied with the vehicle's high speed forward acceleration.
- ⑥-d. Driving at full throttle with the speed limit pot still in its maximum speed position, release the throttle to neutral. Depending on how you liked the deceleration you experienced, increase or decrease the Decel High Speed value. Continue testing and adjusting this value until you are satisfied with the vehicle's high speed forward deceleration.

Reverse acceleration and deceleration rates

- ⑥-e, ⑥-f, ⑥-g, ⑥-h. Adjust Rev Accel Min Speed, Rev Decel Low Speed, Rev Accel Max Speed, and Rev Decel High Speed using the same procedures as for the corresponding Forward parameters.

Fine tuning the acceleration and deceleration rates

- ⑥-i. Drive around in both Mode 1 and Mode 2, while varying the position of the throttle and the speed limit pot. In most cases, setting the

acceleration and deceleration rates as described in Steps 6-a through 6-h will provide good performance throughout. However, you may want to make further adjustments to them.

- Ⓒ-j. For additional softening of the deceleration response, you could adjust the Soft Stop Speed parameter to a larger value (see page 16).
- Ⓒ-k. In rare cases, it may be desirable to adjust the Throttle Map parameter. This parameter can be used, for example, to extend the throttle's gentle acceleration range to further enhance maneuverability in confined areas. See page 19 for a description of Throttle Map.

Key Off deceleration rate

The Key Off Decel parameter sets the decel rate that will be used to slow the vehicle at key-off or in the event of a major fault.

- Ⓒ-l. Drive fast and turn the key off. The deceleration you experience is determined by Key Off Decel.
- Ⓒ-m. Adjust the Key Off Decel value to produce the desirable "feel" for emergency stops: typically as fast as possible without making the vehicle unstable.
- Ⓒ-n. Note that Key Off Decel should always be set faster than (or equal to) the fastest forward deceleration rate, Decel High Speed.

E Stop deceleration rate

The E Stop Decel parameter sets the decel rate that will be used when the vehicle is moving forward and the throttle makes a fast transition through neutral to a >80% reverse throttle request. This provides a way to stop more quickly when unexpected conditions arise.

- Ⓒ-o. Drive fast and throw the throttle into >80% reverse. The deceleration you experience is determined by E Stop Decel.
- Ⓒ-p. Adjust the E Stop Decel value to produce the desirable "feel" for emergency reverse stops: typically as fast as possible without making the vehicle unstable.
- Ⓒ-q. Note that the E Stop Decel rate should always be set faster than (or equal to) the fastest forward deceleration rate, Decel High Speed.
- Ⓒ-r. The E Stop Pause parameter can be used to create a pause after the vehicle has come to an emergency stop, thus giving the operator a chance to return the throttle to neutral before the vehicle starts to travel backwards. Adjust the E Stop Pause value to provide the appropriate pause. A longer pause might be preferred for a vehicle that will be mainly used indoors, whereas for a vehicle that will be used outdoors a faster initiation of reverse travel might be desirable.

⑦ Adjusting IR compensation

The IR Comp parameter is used to set the percentage of the maximum motor resistance that will be applied, i.e., $(\text{IR Comp}) \times (\text{System Resistance})$, to compensate for increased load caused by uneven terrain.

The trade-off in setting this parameter is that as ability to overcome load disturbances increases, operating smoothness decreases. A high IR Comp value will allow the vehicle to continue creeping at a low speed, even though it has just contacted a bump in the threshold of a doorway. But if IR Comp is set too high, it may make the vehicle “jumpy” during normal driving. Small throttle movements in this case may no longer provide gentle linear acceleration, but instead initiate accelerations with a sharp jerk. Therefore, the tuning goal is a balance between adequate load disturbance response and normal acceleration/deceleration response.

The normal range for IR Comp is approximately 50–80%. Larger numbers provide stiffer, stronger response. If the value needs to be much larger or smaller than this range to achieve acceptable performance, the System Resistance has probably not been set up correctly and should be checked. Note: Largely different settings for IR Comp will affect the maximum speeds that were set in Step 5. Therefore, if you make large changes to IR Comp, you should repeat Step 5.

Just before stopping, when the throttle is in neutral, IR Comp is replaced by Anti-Rollback Comp. Typically Anti-Rollback Comp is set about 20% higher than IR Comp.

Assuming that System Resistance is set correctly (within 10–20%), some general rules of thumb apply:

- ⑦-a. If the vehicle is extremely “jumpy” (i.e., responds abruptly to small throttle changes, IR Comp could be set too high.
- ⑦-b. If the vehicle speed varies dramatically when cresting a hill, IR Comp is most likely set too low.
- ⑦-c. If the vehicle rolls the other direction near the end of a stop on flat ground, Anti-Rollback Comp is set too high.
- ⑦-d. If the vehicle is still moving on a modest ramp when the brake gets set, Anti-Rollback Comp is set too low.
- ⑦-e. If the vehicle seems to decelerate to a stop in a nonlinear fashion, Anti-Rollback Comp could be set too high.

⑧ Fine-tuning the vehicle's response smoothness

Three additional parameters—Gear Soften, Soft Start, and Tremor Suppression—are available for softening and smoothing vehicle response. In most cases, these functions can be used to provide smooth vehicle operation while still maintaining a high degree of responsiveness.

Gear Soften and Soft Start are in the Speed menu; Tremor Suppression is in the Throttle menu.

Gear Soften and Soft Start

These two parameters can be set from 0–100%, with 100% providing a great deal of softening and 0% eliminating the function. They have by far the most noticeable effect on older, worn transaxles.

- ⑧-a. Make sure Gear Soften and Soft Start are set to 0%.
- ⑧-b. While driving at both high and low speeds, release the throttle to neutral and then reapply it before coming to a complete stop. Notice how the transaxle gears bump as you reapply the throttle.
- ⑧-c. Change the Gear Soften setting from 0% to 100% and repeat the same exercise. Notice how the slop transition is softened, at the expense of a small bit of nonlinearity in the acceleration rate.
- ⑧-d. Adjust Gear Soften until you find a setting you like, noting that you probably won't notice much of a difference if you're using a brand new, tight transaxle. Some users prefer a softened feel, while others prefer this parameter set to zero because they want complete linearity in response. In setting this parameter, you also may want to take into consideration that softened slack take-up is easier on the transaxle gears and may extend the transaxle operating life.
- ⑧-e. Soft Start is the same as Gear Soften, except it applies to accelerations from zero speed. Note that you'll feel a transaxle bump only if the gears are meshed in the opposite direction when torque is applied, so you may need to nudge the vehicle backwards against the brake when experimenting with this parameter. We recommend relatively small values for the Soft Start parameter (typically < 40%) to avoid excessive delay from a stop. Having separate parameters for the soft start and gear soften functions allows you to set the Soft Start parameter lower than the Gear Soften parameter. Setting the two parameters the same in effect collapses them into a single parameter.

Tremor Suppression

Tremor Suppression adjusts vehicle response to sharp throttle movements, such as those resulting inadvertently from hand tremors. This parameter can be set from 0–100%, with larger values providing steadier response. The tremor compensation function somewhat overlaps the gear softening functions. However, the tremor compensation function is active all the time, while the two gear softening functions are active only during a gear slack transition, i.e., a torque direction reversal.

Generally, we recommend that you do your tuning with Tremor Suppression set to the default value (50%), and then adjust it if necessary as the final piece of tuning—higher values for more suppression, lower values for less. Tremor compensation is most noticeable when the throttle is moved quickly from full to low (but non-neutral) values. The function is bypassed in the neutral state to ensure responsive linear deceleration when the driver commands a stop.

These setup and tuning procedures cover the most critical aspects of vehicle performance. Additional parameters can be used to make further adjustments, if necessary. However, in most cases, the default values of the other parameters prove satisfactory.

7

DIAGNOSTICS AND TROUBLESHOOTING

The 1212 and 1212P controllers provide diagnostics information to assist technicians in troubleshooting drive system problems. The diagnostics information can be obtained in two ways: by reading the appropriate display on the programmer or by observing the fault codes issued by the status LED.

PROGRAMMER DIAGNOSTICS

The programming devices present complete diagnostic information in plain language. Faults are displayed in the Faults/Diagnostics menu, and the status of the controller inputs/outputs is displayed in the Monitor menu.

Additionally, the fault history file in the Faults/Diagnostics menu provides a list of the faults that have occurred since the file was last cleared. Checking (and clearing) the fault history file is recommended each time the vehicle is brought in for maintenance.

Refer to the troubleshooting chart (Table 3) for suggestions about possible causes of the various faults

For information on programming devices, see Appendix D.

LED DIAGNOSTICS

During normal operation, with no faults present, the status LED is steadily on. If the controller detects a fault, the status LED flashes a 2-digit fault identification code continuously until the fault is corrected.

For example, code “1,4”—undervoltage—appears as:

□ □ □ □ □	□ □ □ □ □	□ □ □ □ □
(1 , 4)	(1 , 4)	(1 , 4)

The fault codes are listed in Table 2. Refer to the troubleshooting chart (Table 3) for suggestions about possible causes of the various faults.

Note: The status LED can only indicate one fault at a time. If multiple faults are detected, the highest priority fault code flashes until it is cleared.

FAULT HANDLING

When a fault is detected, the controller operates in a manner that is safe in the presence of that fault. Depending on the severity of the fault, the response can range from reduction of current to complete shutdown of drive.

Table 2 STATUS LED FAULT CODES

LED CODES		FAULT
<i>LED off</i>	■	no power or defective controller controller powered up; no faults
<i>solid on</i>	□	
1,1	□ □	THERMAL FAULT
1,2	□ □□	THROTTLE FAULT
1,3	□ □□□	SPEED POT FAULT
1,4	□ □□□□	UNDERVOLTAGE FAULT
1,5	□ □□□□□	OVERVOLTAGE FAULT
2,1	□□ □	MAIN OFF FAULT
2,2	□□ □□	EMR SEQUENCING FAULT / MOTOR STALLED
2,3	□□ □□□	MAIN FAULT *
2,4	□□ □□□□	MAIN ON FAULT
2,5	□□ □□□□□	PUMP SRO FAULT
3,1	□□□ □	WIRING FAULT *
3,2	□□□ □□	BRAKE ON FAULT
3,3	□□□ □□□	PRECHARGE FAULT *
3,4	□□□ □□□□	BRAKE OFF FAULT
3,5	□□□ □□□□□	HPD FAULT
4,1	□□□□ □	CURRENT SENSE FAULT *
4,2	□□□□ □□	HARDWARE FAILSAFE *
4,3	□□□□ □□□	EE CHECKSUM FAULT †
4,4	□□□□ □□□□	MOTOR OPEN
4,5	□□□□ □□□□□	BATTERY DISCONNECT FAULT *

* = *Must cycle keyswitch to clear.*

† = *Must use programmer to clear, as follows: select Program menu, alter data value of any parameter, cycle keyswitch.*

Table 3 TROUBLESHOOTING CHART

LED CODE	PROGRAMMER LCD DISPLAY	EXPLANATION	POSSIBLE CAUSE
1,1	THERMAL FAULT	over-/under-temperature cutback	1. Temperature >80°C or < -10°C. 2. Excessive load on vehicle. 3. Operation in extreme environments. 4. Electromagnetic brake not releasing.
1,2	THROTTLE FAULT	PotLow and/or PotWiper out of range	1. Throttle input wire open or shorted. 2. Throttle pot defective. 3. Wrong throttle type selected.
1,3	SPEED POT FAULT	speed limit pot wiper out of range	1. Speed limit pot wire(s) broken or shorted. 2. Broken speed limit pot.
1,4	UNDERVOLTAGE FAULT	battery voltage too low	1. Battery voltage <17 volts. 2. Bad connection at battery or controller.
1,5	OVERVOLTAGE FAULT	battery voltage too high	1. Battery voltage >31 volts. 2. Vehicle operating with charger attached. 3. Intermittent battery connection.
2,1	MAIN OFF FAULT	main contactor driver Off fault	1. Main contactor driver failed open.
2,2	EMR SEQUENCING FAULT [1212P]	improper sequencing	1. Emerg. Rev. switch pressed before KSI on.
	MOTOR STALLED [1212]	motor stall fault	1. Motor is stalled.
2,3	MAIN FAULT	main contactor fault	1. Main contactor welded or stuck open. 2. Main contactor driver fault.
2,4	MAIN ON FAULT	main contactor driver On fault	1. Main contactor driver failed closed.
2,5	PUMP SRO FAULT [1212P]	improper sequencing	1. Pump switches pressed before KSI on.
3,1	WIRING FAULT	HPD fault present >10 sec.	1. Misadjusted throttle. 2. Broken throttle pot or throttle mechanism.
3,2	BRAKE ON FAULT	brake On fault	1. Electromagnetic brake driver shorted. 2. Electromagnetic brake coil open.
3,3	PRECHARGE FAULT	precharge fault	1. Brake driver shorted. 2. Precharge circuit damaged. 3. MOSFET failure.
3,4	BRAKE OFF FAULT	brake Off fault	1. Electromagnetic brake driver open. 2. Electromagnetic brake coil shorted.
3,5	HPD FAULT	HPD (High Pedal Disable)	1. Improper sequence of throttle and KSI, push, or inhibit inputs. 2. Misadjusted throttle pot.

Table 3 TROUBLESHOOTING CHART, cont'd

LED CODE	PROGRAMMER LCD DISPLAY	EXPLANATION	POSSIBLE CAUSE
4,1	CURRENT SENSE FAULT	current sense out of range	1. Short in motor or in motor wiring. 2. Controller failure. ★
4,2	HARDWARE FAILSAFE	motor voltage out of range	1. Motor voltage does not correspond to throttle request. 2. Short in motor or in motor wiring. 3. Controller failure. ★
4,3	EEPROM CHECKSUM FAULT	EEPROM fault	1. EEPROM failure or fault.
4,4	MOTOR OPEN [1212]	motor open fault	1. Motor wiring is open.
4,5	BATTERY DISCONNECT FAULT	battery disconnected	1. Battery not connected. 2. Poor connection to battery terminals.

★ Jack up vehicle and retest to confirm diagnosis. Clean connections, inspect system wiring, and retest.

8

MAINTENANCE

There are no user serviceable parts in Curtis 1212/1212P controllers. **No attempt should be made to open, repair, or otherwise modify the controller.** Doing so may damage the controller and will void the warranty. However, it is recommended that the controller's fault history file be checked and cleared periodically, as part of routine vehicle maintenance.

DIAGNOSTIC HISTORY

The handheld programmer can be used to access the controller's fault history file. The programmer will read out all the faults that the controller has experienced since the last time the history file was cleared. The faults may be intermittent faults, faults caused by loose wires, or faults caused by operator errors. Faults such as HPD or overtemperature may be caused by operator habits or by overloading.

After a problem has been diagnosed and corrected, clearing the history file is advisable. This allows the controller to accumulate a new file of faults. By checking the new history file at a later date, you can readily determine whether the problem was indeed completely fixed.

APPENDIX A

VEHICLE DESIGN CONSIDERATIONS REGARDING ELECTROMAGNETIC COMPATIBILITY (EMC)

Electromagnetic compatibility (EMC) encompasses two areas: emissions and immunity. *Emissions* are radio frequency (RF) energy generated by a product. This energy has the potential to interfere with communications systems such as radio, television, cellular phones, dispatching, aircraft, etc. *Immunity* is the ability of a product to operate normally in the presence of RF energy.

EMC is ultimately a system design issue. Part of the EMC performance is designed into or inherent in each component; another part is designed into or inherent in end product characteristics such as shielding, wiring, and layout; and, finally, a portion is a function of the interactions between all these parts. The design techniques presented below can enhance EMC performance in products that use Curtis motor controllers.

Emissions Signals with high frequency content can produce significant emissions if connected to a large enough radiating area (created by long wires spaced far apart). Contactor drivers and the motor drive output from Curtis controllers can contribute to RF emissions. Both types of output are pulse width modulated square waves with fast rise and fall times that are rich in harmonics. (Note: contactor drivers that are not modulated will not contribute to emissions.) The impact of these switching waveforms can be minimized by making the wires from the controller to the contactor or motor as short as possible and by placing the wires near each other (bundle contactor wires with Coil Return; bundle motor wires separately).

For applications requiring very low emissions, the solution may involve enclosing the controller, interconnect wires, contactors, and motor together in one shielded box. Emissions can also couple to battery supply leads and throttle circuit wires outside the box, so ferrite beads near the controller may also be required on these unshielded wires in some applications. It is best to keep the noisy signals as far as possible from sensitive wires.

Immunity Immunity to radiated electric fields can be improved either by reducing overall circuit sensitivity or by keeping undesired signals away from this circuitry. The controller circuitry itself cannot be made less sensitive, since it must accurately detect and process low level signals from sensors such as the throttle potentiometer. Thus immunity is generally achieved by preventing the external RF energy from coupling into sensitive circuitry. This RF energy can get into the controller circuitry via conducted paths and radiated paths.

Conducted paths are created by the wires connected to the controller. These wires act as antennas and the amount of RF energy coupled into them is generally proportional to their length. The RF voltages and currents induced in each wire are applied to the controller pin to which the wire is connected. Curtis controllers include bypass capacitors on the printed circuit board's throttle wires to reduce the impact of this RF energy on the internal circuitry. In some applications, additional filtering in the form of ferrite beads may also be required on various wires to achieve desired performance levels.

Radiated paths are created when the controller circuitry is immersed in an external field. This coupling can be reduced by placing the controller as far as possible from the noise source or by enclosing the controller in a metal box. Some Curtis controllers are enclosed by a heatsink that also provides shielding around the controller circuitry, while others are partially shielded or unshielded. In some applications, the vehicle designer will need to mount the controller within a shielded box on the end product. The box can be constructed of just about any metal, although steel and aluminum are most commonly used.

Most coated plastics do not provide good shielding because the coatings are not true metals, but rather a mixture of small metal particles in a non-conductive binder. These relatively isolated particles may appear to be good based on a dc resistance measurement but do not provide adequate electron mobility to yield good shielding effectiveness. Electroless plating of plastic will yield a true metal and can thus be effective as an RF shield, but it is usually more expensive than the coatings.

A contiguous metal enclosure without any holes or seams, known as a Faraday cage, provides the best shielding for the given material and frequency. When a hole or holes are added, RF currents flowing on the outside surface of the shield must take a longer path to get around the hole than if the surface was contiguous. As more “bending” is required of these currents, more energy is coupled to the inside surface, and thus the shielding effectiveness is reduced. The reduction in shielding is a function of the longest linear dimension of a hole rather than the area. This concept is often applied where ventilation is necessary, in which case many small holes are preferable to a few larger ones.

Applying this same concept to seams or joints between adjacent pieces or segments of a shielded enclosure, it is important to minimize the open length of these seams. Seam length is the distance between points where good ohmic contact is made. This contact can be provided by solder, welds, or pressure contact. If pressure contact is used, attention must be paid to the corrosion characteristics of the shield material and any corrosion-resistant processes applied to the base material. If the ohmic contact itself is not continuous, the shielding effectiveness can be maximized by making the joints between adjacent pieces overlapping rather than abutted.

The shielding effectiveness of an enclosure is further reduced when a wire passes through a hole in the enclosure; RF energy on the wire from an external field is re-radiated into the interior of the enclosure. This coupling mechanism can be reduced by filtering the wire where it passes through the shield boundary. Given the safety considerations involved in connecting electrical components to the chassis or frame in battery powered vehicles, such filtering will usually consist of a series inductor (or ferrite bead) rather than a shunt capacitor. If a capacitor is used, it must have a voltage rating and leakage characteristics that will allow the end product to meet applicable safety regulations.

The B+ (and B-, if applicable) wires that supply power to a control panel should be bundled with the other control wires to the panel so that all these wires are routed together. If the wires to the control panel are routed separately, a larger loop area is formed. Larger loop areas produce more efficient antennas which will result in decreased immunity performance.

Keep all low power I/O separate from the motor and battery leads. When this is not possible, cross them at right angles.

APPENDIX B

EN 13849 COMPLIANCE, CURTIS 1212P CONTROLLER

Since January 1, 2012, conformance to the European Machinery Directive has required that the Safety Related Parts of the Control System (SRPCS) be designed and verified upon the general principles outlined in EN13849. EN13849 supersedes the EN954 standard and expands upon it by requiring the determination of the safety Performance Level (PL) as a function of Designated Architecture plus Mean Time To Dangerous Failure (MTTFd), Common Cause Faults (CCF), and Diagnostic Coverage (DC). These figures are used by the OEM to calculate the overall PL for each of the safety functions of their vehicle or machine.

The OEM must determine the hazards that are applicable to their vehicle design, operation, and environment. Standards such as EN13849-1 provide guidelines that must be followed in order to achieve compliance. Some industries have developed further standards (called type-C standards) that refer to EN13849 and specifically outline the path to regulatory compliance. EN1175-1 is a type-C standard for battery-powered industrial trucks. Following a type-C standard provides a presumption of conformity to the Machinery Directive.

Curtis 1212P controllers comply with these directives using basic “watch-dog” test circuits; see the simplified block diagram in Figure B-1.

Fig. B-1 Safety channel block diagram, Curtis 1212P controller.

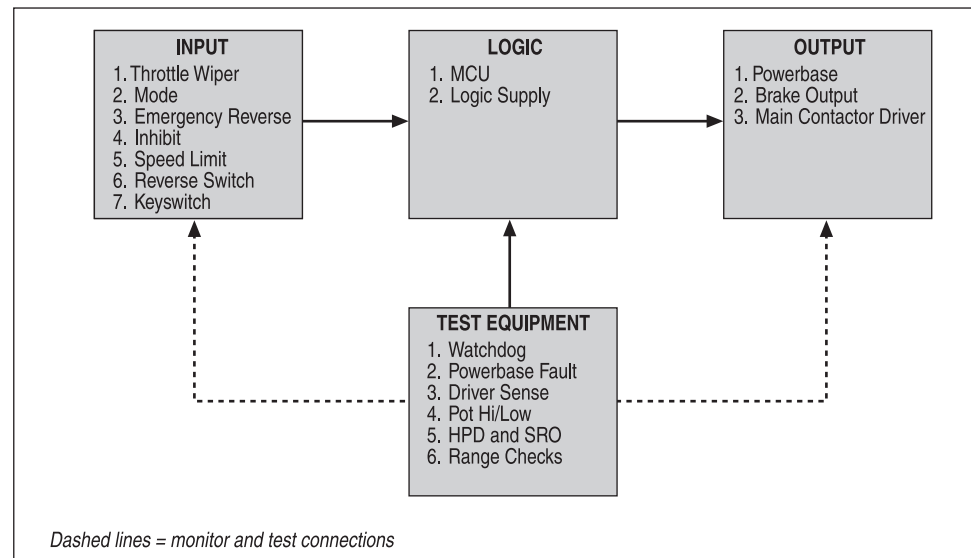

To mitigate the hazards typically found in machine operations, EN13849 requires that safety functions be defined; these must include all the input, logic, outputs, and power circuits that are involved in any potentially hazardous operation. Three safety functions are defined for the Curtis 1212P controller: (1) crushing due to unintended or uncontrolled movement; (2) crushing through loss of STO/braking; and (3) loss of stability from excessive speeds, as specified by vehicle limits.

Curtis has analyzed each safety function and calculated its Mean Time To Dangerous Failure (MTTFd) and Diagnostic Coverage (DC), and designed them against Common Cause Faults (CCF). The safety-related performance of the Curtis 1212P is summarized as follows:

Safety Function	Designated Architecture	MTTFd	DC	CCF Score	PL
Crushing*	2	≥22 yrs	≥ 60%	70	c
Crushing**	2	≥22 yrs	≥ 60%	70	c
Loss of stability***	2	≥22 yrs	≥ 60%	70	c
* due to unintended or uncontrolled movement ** through loss of STO/braking *** from excessive speeds, as specified by vehicle limits					

EN1175 specifies that traction and hydraulic electronic control systems must use Designated Architecture 2 or greater. This design employs input, logic, and output circuits that are monitored and tested by independent circuits and software to ensure a high level of safety performance (up to PL=d).

Mean Time To Dangerous Failure (MTTFd) is related to the expected reliability of the safety related parts used in the controller. Only failures that can result in a dangerous situation are included in the calculation.

Diagnostic Coverage (DC) is a measure of the effectiveness of the control system's self-test and monitoring measures to detect failures and provide a safe shutdown.

Common Cause Faults (CCF) are so named because some faults within a controller can affect several systems. EN13849 provides a checklist of design techniques that should be followed to achieve sufficient mitigation of CCFs. All circuits used by a safety function must be designed in such a way as to score 65 or better on the CCF score sheet as provided by EN13849 table F.1.

Performance Level (PL) categorizes the quality or effectiveness of a safety channel to reduce the potential risk caused by dangerous faults within the system with "a" being the lowest and "e" being the highest achievable performance.

Contact Curtis technical support for more details.

APPENDIX C

BATTERY DISCHARGE INDICATOR (BDI) SETUP

The Battery Discharge Indicator used with the 1212/1212P is quite flexible and, once set up, will provide the user with reliable information on the status of the battery system.

The BDI parameters (Program»BDI menu) must be set up specifically for the type and size of the charger, the battery size, and the vehicle's expected drive cycle.

When setting up the BDI parameters, use the same vehicle and set of batteries for the entire procedure. Do not drive the vehicle or charge the batteries except when requested to do so in the procedure.

Follow the steps in the order they are presented.

Before beginning the procedure, set the following initial values:

Full Voltage	=	24.4
Empty Voltage	=	20.8
Full Charge Voltage	=	28.2
Start Charge Voltage	=	25.2
Reset Voltage	=	25.0
Discharge Factor	=	2.0
Charge Factor	=	2.0
Low BDI Level	=	0
Low BDI Max Speed	=	50.

Step 1. Setting the Reset Voltage

- 1.a Plug in the charger, and fully charge the batteries. With the charger still attached and running, measure the final battery voltage with a Digital Volt Meter (DVM).
- 1.b Set the Full Charge Voltage 0.2 V lower than the measured value.
- 1.c Turn off or disconnect the charger and let the batteries sit for 1 hour. Measure the battery voltage again.
- 1.d Set the Reset Voltage 0.2 V lower than the new measured value.

Step 2. Setting the Full Voltage

- 2.a Select a medium speed mode and drive the vehicle for 10–15 minutes.
- 2.b After this time and while driving straight on a level surface, record the battery voltage displayed in the 1311's Monitor menu.
- 2.c Set the Full Voltage parameter to this value.

Step 3. Setting the Empty Voltage

- 3.a Normally a value of 1.7 volts per cell is used as the empty point. This corresponds to a setting of 20.4 V. For some sealed batteries, this may be too low. Consult the battery manufacturer if you are unsure.

Step 4. Setting the Discharge Factor

- 4.a Resume driving the vehicle, with a heavy load.
- 4.b Pay attention to the battery voltage, BDI, and time.
- 4.c At some point, you will feel the vehicle become sluggish and notice the battery voltage drop significantly with basic maneuvers. This is the fully discharged point of the battery. Stop driving.
- 4.d The BDI should have indicated 0% before this point, to prevent the battery pack from wearing out prematurely.
- 4.e If the BDI does not read 0%, reduce the Discharge Factor parameter proportionately to the indicated remaining BDI. Use this formula to determine the new setting:

New Discharge Factor = Present Discharge Factor * (1 – BDI%),
with the BDI% being expressed decimally (e.g., 90% = 0.90).

Step 5. Setting the Charge Factor and Start Charge Voltage

How you set the Charge Factor and Start Charge Voltage parameters depends on how you want the BDI gauge to respond to partial charging. The traditional method is to require a full recharge and not to reset the BDI gauge until the battery is full. The 1212/1212P can also be programmed to allow the user to stop the charge in mid-cycle and display a proportional amount of charge, or “partial charge” reading.

If you want to require a full charge to reset the BDI gauge:

- 5.a Set the Charge Factor to 10.0.
- 5.b Set the Start Charge Voltage equal to the Full Charge Voltage.

With these settings, the BDI will not recalculate until the very end of the charge cycle, and the Reset Voltage—not the charge time—will trigger the BDI to 100%.

If you want to use the partial charge feature:

- 5.c Based on the Amp Hour rating of the batteries and the charger’s average amp output, initially calculate and set the Charge Factor using this formula:

Charge Factor = 1.5 * (Battery amp-hrs / Charger amps).

- 5.d Starting with the dead battery from Step 4, plug in the charger. After 10 minutes of charging, measure the battery voltage with a meter. Set the Start Charge Voltage parameter to this value.

Step 6. Rerun and Verify

This procedure will give good initial settings for the BDI algorithm. You should test these settings under various conditions to verify that they provide an acceptable indication of the battery state of charge. The settings can be fine tuned by repeating the entire procedure.

It is important to note that battery age and driving conditions (hilliness, driving surface, weight of user) will all affect the accuracy of the BDI measurement.

APPENDIX D

PROGRAMMING DEVICES

Curtis programmers provide programming, diagnostic, and test capabilities for the 1212/1212P controllers. The power for operating the programmer is supplied by the host controller via a 4-pin connector. When the programmer powers up, it gathers information from the controller.

Two types of programming devices are available: the 1314 PC Programming Station and the 1313 handheld programmer. The Programming Station has the advantage of a large, easily read screen; on the other hand, the handheld programmer (with its 45×60mm screen) has the advantage of being more portable and hence convenient for making adjustments in the field.

Both programmers are available in User, Service, Dealer, and OEM versions. Each programmer can perform the actions available at its own level and the levels below that—a User-access programmer can operate at only the User level, whereas an OEM programmer has full access.

PC PROGRAMMING STATION (1314)

The Programming Station is an MS-Windows 32-bit application that runs on a standard Windows PC. Instructions for using the Programming Station are included with the software.

HANDHELD PROGRAMMER (1313)

The 1313 handheld programmer is functionally equivalent to the PC Programming Station; operating instructions are provided in the 1313 manual. This programmer replaces the 1311, an earlier model with fewer functions.

PROGRAMMER FUNCTIONS

Programmer functions include:

Parameter adjustment — provides access to the individual programmable parameters.

Monitoring — presents real-time values during vehicle operation; these include all inputs and outputs.

Diagnostics and troubleshooting — presents diagnostic information, and also a means to clear the fault history file.

Programming — allows you to save/restore custom parameter settings files and also to update the system software (not available on the 1311).

Favorites — allows you to create shortcuts to your frequently-used adjustable parameters and monitor variables (not available on the 1311).

APPENDIX E SPECIFICATIONS

Table E-1 SPECIFICATIONS: 1212 CONTROLLER

Nominal input voltage	24 V
PWM operating frequency	15.6 kHz
Electrical isolation to heatsink (min.)	500 V
Minimum motor resistance	160 m Ω (45 amp models); 120 m Ω (70 amp and 90 amp models)
B+, B- logic pin current (max.)	9 A (pins 7 and 13 on 14-pin connector)
KSI input current (typical)	80 mA
Logic input current (typical)	1 mA
Horn output current (max.)	15 mA
Lift lockout output current (max.)	50 mA [1212P only]
BDI output voltage, resistance (max.)	0–5 V, 10 k Ω
LED output current (max.)	15 mA
Electromagnetic brake coil resistance (min.)	32 Ω
Throttle type	resistance or voltage; single-ended, inverted single-ended, wigwag, inverted wigwag, or unipolar
Storage ambient temperature range	-40°C to 65°C (-40°F to 149°F)
Operating ambient temp. range	-25°C to 50°C (-13°F to 122°F)
Heatsink overtemperature	linear cutback starts at 80°C (176°F); complete cutoff at 105°C (221°F)
Heatsink undertemperature	cutback starts at -10°C (14°F) and is reduced linearly to 50% at -25° (-13°F)
Undervoltage cutoff	14 V
Overvoltage cutoff	34 V
Package environmental rating	ISTA 2A; electronics sealed to IPX5
Weight	0.3 kg (0.7 lbs)
Dimensions (W×L×H)	72 × 131 × 39 mm (2.8" × 5.2" × 1.5")
Regulatory compliance, 1212	Designed to meet EN 12184, EN 55022, IEC 61000-6-2 & -4-6, and ISO 7176 FDA documentation filed TÜV Certification pending.
Regulatory compliance, 1212P	Designed to meet EN 12895, EN 1175, EN 13849, and UL 583.

MODEL NUMBER	NOMINAL BATTERY VOLTAGE (volts)	20, 10 SECOND CURRENT RATING (amps)	2 MINUTE CURRENT RATING (amps)	1 HOUR CURRENT RATING (amps)	PEAK BOOST CURRENT (amps)	MAX BOOST CURRENT DURATION (seconds)
1212-22xx	24	45 (20 s)	40	15	55	10
1212-24xx	24	70 (20 s)	50	20	80	10
1212P-25xx	24	90 (10 s)	50	20	90	N/A

Note: All current ratings are rms values per motor phase. Internal algorithms automatically reduce maximum current limit when heatsink temperature is >80°C or battery voltage is outside the allowed limits. Heatsink temperature is measured internally near the power MOSFETs.

