MANUAL

MODEL **1 2 2 8**

MultiMode™
MOTOR CONTROLLER

© 2003 CURTIS INSTRUMENTS, INC.

DESIGN OF CURTIS PMC 1200 SERIES
CONTROLLERS PROTECTED BY U.S.
PATENT NO. 4626750.

CURTIS

CURTIS INSTRUMENTS, INC.

200 Kisco Avenue
Mount Kisco, NY 10509 USA
Tel: 914-666-2971
Fax: 914-666-2188
www.curtisinst.com

1228 Manual, p/n 36148
Rev. B: April 2003

CONTENTS	
1. OVERVIEW	1
2. INSTALLATION AND WIRING	4
Mounting the Controller	4
Connections: High Current	5
Connections: Low Current	5
Wiring: Applications with Seat Lift	6
Wiring: Applications without Seat Lift	8
Throttle Wiring	10
5k Ω , 3-wire potentiometer throttle	10
5V throttle	10
Curtis ET-XXX electronic throttle	11
Speed limit pot	12
Switches and Other Hardware	12
Keyswitch	12
Push switch	12
Brake release switch	13
Inhibit	13
Status LED	13
Battery discharge indicator	14
Horn	14
Circuitry protection devices	14
Seat lift switch	14
3. PROGRAMMABLE PARAMETERS	15
Motor Parameters	17
Main Current Limit	17
Motor Resistance	17
Acceleration Parameters	17
Maximum-Speed Forward Acceleration Rate	17
Minimum-Speed Forward Acceleration Rate	17
Maximum-Speed Reverse Acceleration Rate	18
Minimum-Speed Reverse Acceleration Rate	18
Gear Soften	18
Soft Start	18
Braking Parameters	19
Maximum-Speed Forward Deceleration Rate	19
Minimum-Speed Forward Deceleration Rate	19
Emergency Stop Deceleration Rate	19
Maximum-Speed Reverse Deceleration Rate	19
Minimum-Speed Reverse Deceleration Rate	20

Key-Off Deceleration Rate.....	20	=====
Brake Delay	20	=====
Speed Parameters	20	=====
Maximum Speed, M1/M2	20	=====
Minimum Speed, M1/M2	21	=====
Maximum Reverse Speed, M1/M2	21	=====
Minimum Reverse Speed	21	=====
Creep Speed	21	=====
Push Speed	21	=====
IR Compensation	22	=====
Speed Scaler	22	=====
Throttle Parameters	22	=====
Throttle Input Signal Type	22	=====
Throttle Autocalibration	23	=====
Throttle Deadband	23	=====
Throttle Gain	25	=====
Ramp Shape (Static Throttle Map)	26	=====
Fault Parameters	27	=====
High Pedal Disable (HPD)	27	=====
Brake Faults	28	=====
Seat Lift Brake Faults	28	=====
Fault Beep	28	=====
Other Parameters	28	=====
Seat Lift	28	=====
Virtual Seat Lift	29	=====
Beeper Solid	29	=====
Ampere Hours	29	=====
BDI Full Voltage	29	=====
BDI Empty Voltage	30	=====
BDI Reset Voltage	30	=====
Sleep Delay	30	=====
Tremor Compensation	30	=====
4. INITIAL SETUP	31	=====
Beginning the Setup Procedures	31	=====
Throttle	31	=====
Basic Vehicle Checkout	33	=====
Determining Motor Resistance	33	=====
5. VEHICLE PERFORMANCE ADJUSTMENT	34	=====
Setting the Maximum Speeds	34	=====
Setting the Acceleration and Deceleration Rates	34	=====
Adjusting Load Compensation	37	=====
Fine-Tuning the Vehicle's Response Smoothness	38	=====

6. PROGRAMMER MENUS	40	=====
1228 Program Menu	40	=====
1228 Test Menu	42	=====
1228 Diagnostics and Diagnostic History	42	=====
7. DIAGNOSTICS AND TROUBLESHOOTING	43	=====
Programmer Diagnostics	43	=====
LED Diagnostics	43	=====
Troubleshooting Chart	45	=====
8. MAINTENANCE	46	=====
APPENDIX A Vehicle Design Considerations Regarding Electromagnetic Compatibility (EMC) and Electrostatic Discharge (ESD)	A-1	=====
APPENDIX B 1311 Programmer Operation	B-1	=====
APPENDIX C Index to Programmable Parameters	C-1	=====
APPENDIX D Specifications	D-1	=====

FIGURES

FIG. 1:	Curtis 1228 electronic motor controller	1
FIG. 2:	Mounting dimensions, Curtis 1228 controller	4
FIG. 3a:	Standard wiring configuration, with seat lift	6
FIG. 3b:	Alternative wiring configuration, with seat lift	7
FIG. 4a:	Standard wiring configuration, without seat lift	8
FIG. 4b:	Alternative wiring configuration, without seat lift	9
FIG. 5:	Wiring for 5K Ω , 3-wire potentiometer	10
FIG. 6:	Wiring for 5V throttle	11
FIG. 7:	Wiring for Curtis ET-XXX electronic throttle	11
FIG. 8:	Wiring to inhibit operation during battery charging	13
FIG. 9:	Effect of adjusting the neutral deadband parameter	24
FIG. 10:	Effect of adjusting the throttle gain parameter	25
FIG. 11:	Ramp shape (throttle map) for controller with maximum speed set at 100%	26
FIG. 12:	Ramp shape (throttle map) for controller with maximum speed set at 60%	27
FIG. B-1:	Curtis 1311 handheld programmer	B-1

TABLES

TABLE 1:	Programmable throttle input signal types	22
TABLE 2:	Status LED fault codes	45
TABLE 3:	Troubleshooting chart	46
TABLE C-1:	Parameter index	C-1
TABLE D-1:	Specifications, 1228 controller	D-1

1

OVERVIEW

The Curtis 1228 MultiMode™ controller is a permanent magnet motor speed controller designed for use in mobility aid scooters and other small electric vehicles, such as sweeper/scrubbers. It offers smooth, silent, cost effective control of motor speed and torque. A four quadrant, full bridge power output stage provides for solid state motor reversing and full braking power without additional relays or contactors.

The 1228 controller is fully programmable by means of the Curtis 1311 handheld programmer. Use of the programmer offers diagnostic and test capability as well as configuration flexibility.

Fig. 1 Curtis 1228 MultiMode™ electronic motor controller.



Like all Curtis motor controllers, the 1228 offers superior operator control of the vehicle's motor drive speed. In addition, the 1228 controls the seat lift motor if one is used. **Features include:**

- ✓ Full bridge power MOSFET design, providing
 - infinitely variable forward, reverse, drive, and brake control
 - silent high frequency operation
 - high efficiency
- ✓ Programmability through the Curtis handheld programmer
- ✓ Complete diagnostics through the handheld programmer and a status LED
- ✓ Full compliance with all applicable international standards

More Features ➞

- ✓ Available for single-ended or wigwag 5k Ω potentiometer throttles and 5V throttles (both standard full stroke and restricted range)
- ✓ MultiMode™ input selects between two different operating modes, thus allowing optimization of vehicle characteristics for different driving conditions (for example, indoor/outdoor)
- ✓ Speed limit input provides linear variable speed limiting when an external speed limit pot is used
- ✓ Current limiting in both driving and regenerative braking modes
- ✓ Load compensation stabilizes speed on ramps and over obstacles
- ✓ Speed scaler eliminates variations in maximum speed that would otherwise result from variations in battery charge levels
- ✓ High pedal disable (HPD) function with lockout monitors status of the throttle during turn-on and prevents operation until the throttle has been returned to neutral
- ✓ Key-off deceleration function provides a controlled deceleration if the keyswitch is turned off while driving
- ✓ “E Stop” provides a faster deceleration for emergency stops
- ✓ Seat lift function simplifies the wiring required to implement seat lift in DME scooter applications
- ✓ Comprehensive fault detection monitors main contactor, output stage, throttle demand vs. output, etc., and disables the drive functions if any conditions are outside specified limits
- ✓ ISO 7176 compliant throttle fault detection circuitry inhibits driving if throttle pot signal goes out of range for any reason
- ✓ Missing/shorted brake detection forces neutral in the event of an open or shorted brake circuit
- ✓ Anti-rollback/anti-roll-forward function sets brake delay according to speed and direction for improved braking response and minimized rollback on hills, etc.
- ✓ Reverse beeper option can be used to drive a low current dc horn when vehicle is in reverse
- ✓ “Push” input electrically releases brake for key-on pushing (requires that the vehicle be stopped first)
- ✓ “Push-Too-Fast” feature guards against unpowered vehicle runaway by powering up and regulating motor voltage to limit vehicle speed
- ✓ Inhibit input disables the controller and puts the vehicle in a safe state during charging, etc.

- ✓ Power saver deactivates the main relay after 25 seconds of non-operation and deactivates the entire controller after the programmed sleep delay has elapsed
- ✓ BDI output can be used to provide data to a voltmeter; the BDI output can be “stuffed” (optional) in order to display the battery state of charge during battery charging even while the keyswitch is turned off
- ✓ Undervoltage cutback function protects against operation at low battery voltage
- ✓ Overvoltage protection shorts the motor and disables driving in the event of excessive battery voltage
- ✓ Thermally protected
- ✓ Reverse polarity protected (battery input)

Familiarity with your Curtis controller will help you install and operate it properly. We encourage you to read this manual carefully. If you have questions, please contact the Curtis office nearest you.



Working on electric vehicles is potentially dangerous. You should protect yourself against runaways, high current arcs, and outgassing from lead acid batteries:

RUNAWAYS — Some conditions could cause the vehicle to run out of control. Disconnect the motor or jack up the vehicle and get the drive wheels off the ground before attempting any work on the motor control circuitry. Note: If the wrong combination of throttle and switch styles is selected with the handheld programmer, the vehicle may suddenly begin to move.

HIGH CURRENT ARCS — Electric vehicle batteries can supply very high power, and arcs can occur if they are short circuited. Always open the battery circuit before working on the motor control circuit. Wear safety glasses, and use properly insulated tools to prevent shorts.

LEAD ACID BATTERIES — Charging or discharging generates hydrogen gas, which can build up in and around the batteries. Follow the battery manufacturer’s safety recommendations. Wear safety glasses.

2

INSTALLATION AND WIRING

MOUNTING THE CONTROLLER

The 1228 controller can be oriented in any position, but **the location should be carefully chosen to keep the controller clean and dry. If a clean, dry mounting location cannot be found, a cover must be used to shield the controller from water and contaminants.**

The outline and mounting hole dimensions are shown in Figure 2. The controller should be mounted by means of the two mounting holes at the opposing corners of the heatsink, using M4 × 20 mm (#8 × 0.75") screws. This will give 6 mm (0.25") of exposed screw, which can be increased according to the thickness of the mounting site.

Fig. 2 *Mounting dimensions, Curtis 1228 controller.*

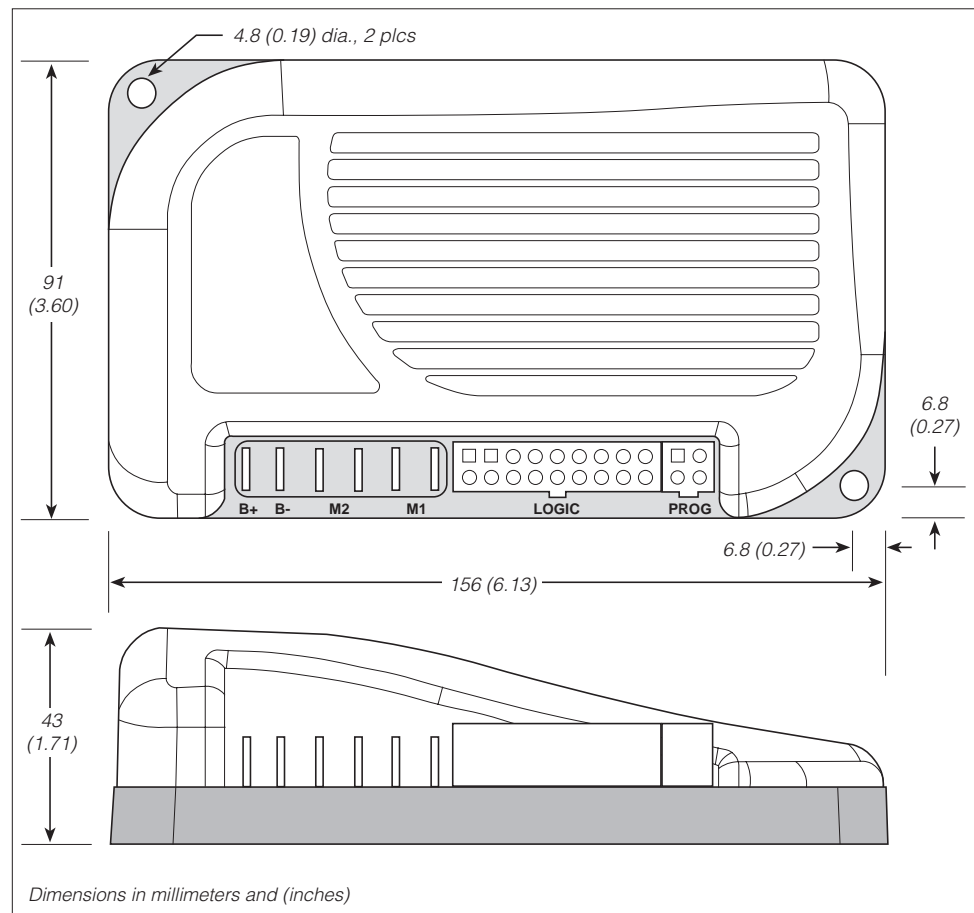

You will need to take steps during the design and development of your end product to ensure that its EMC performance complies with applicable regulations; suggestions are presented in Appendix A.

The 1228 controller contains **ESD-sensitive components**. Use appropriate precautions in connecting, disconnecting, and handling the controller. See installation suggestions in Appendix A for protecting the controller from ESD damage.



CONNECTIONS: High Current

Six 1/4" quick-connect terminals are provided for the high current connections. Two terminals each are provided for the motor **M1** and **M2** connections. The battery connections (**B+**, **B-**) have one terminal each.

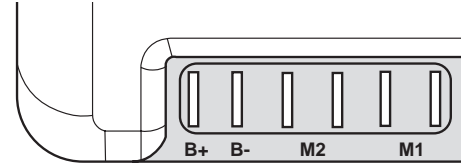

CONNECTIONS: Low Current

The low current logic control connections are provided by an 18-pin connector (see pin list below). The Molex Mini-Fit Jr. p/n 39-01-2185 with type 5556 pins is the mating connector; see chart at left for pin part numbers.

Two identical sets of B+/B- pins are provided; they are electrically connected to the controller's **B+**, **B-** terminals and are rated at 9 amps. If these pins are used, they should be fused appropriately to protect the controller.

Molex Type 5556 Pins	
<i>Brass / Tin</i>	
AWG	P/N
16	39-00-0078
18-24	39-00-0039
22-28	39-00-0047
<i>Phosphor Bronze / Tin</i>	
AWG	P/N
16	39-00-0080
18-24	39-00-0060
22-28	39-00-0066

NOTE: 16 AWG wire and pins are recommended for the battery charger circuit.

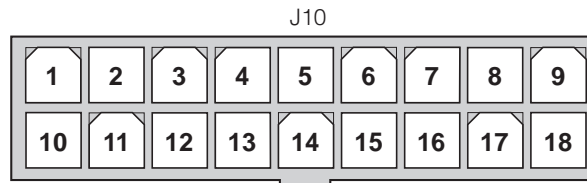

J10 Pin 1	B- (for logic circuit or battery charger)
J10 Pin 2	B- (for logic circuit or battery charger)
J10 Pin 3	pot high output
J10 Pin 4	pot wiper input; 5V throttle input
J10 Pin 5	keyswitch input (KSI)
J10 Pin 6	electromagnetic brake input (brake -)
J10 Pin 7	push switch input
J10 Pin 8	mode switch input—M1 (open), M2 (closed)
J10 Pin 9	status LED output
J10 Pin 10	B+ (for logic circuit or battery charger)
J10 Pin 11	B+ (for logic circuit or battery charger)
J10 Pin 12	inhibit input
J10 Pin 13	pot low input
J10 Pin 14	electromagnetic brake output (brake +)
J10 Pin 15	BDI output
J10 Pin 16	horn input
J10 Pin 17	reverse switch input
J10 Pin 18	speed limit pot wiper input

J9 Pin 1	receive data (+5V)
J9 Pin 2	ground (B-)
J9 Pin 3	transmit data (+5V)
J9 Pin 4	+15V supply (100mA)



A 4-pin low power connector is provided for the programmer. This connector is also used to implement the seat lift feature. When you want to use the programmer, unplug the seat lift connector and plug in the programmer.

WIRING: STANDARD INSTALLATION

Applications with Seat Lift Feature

The wiring diagram presented in Figure 3a shows a typical installation for applications with the seat lift feature. This installation includes a single-ended, 3-wire 5kΩ potentiometer throttle, which is used with a reverse switch. With a wigwag throttle, a reverse switch is not used and Pin 17 is left unconnected.

In this example, one set of B+/B- pins is left unused because the logic circuit is wired directly to the vehicle's battery pack.

Note: When using the B+ pins (10, 11) an appropriately sized fuse must be added to the circuit to avoid damage to the controller.

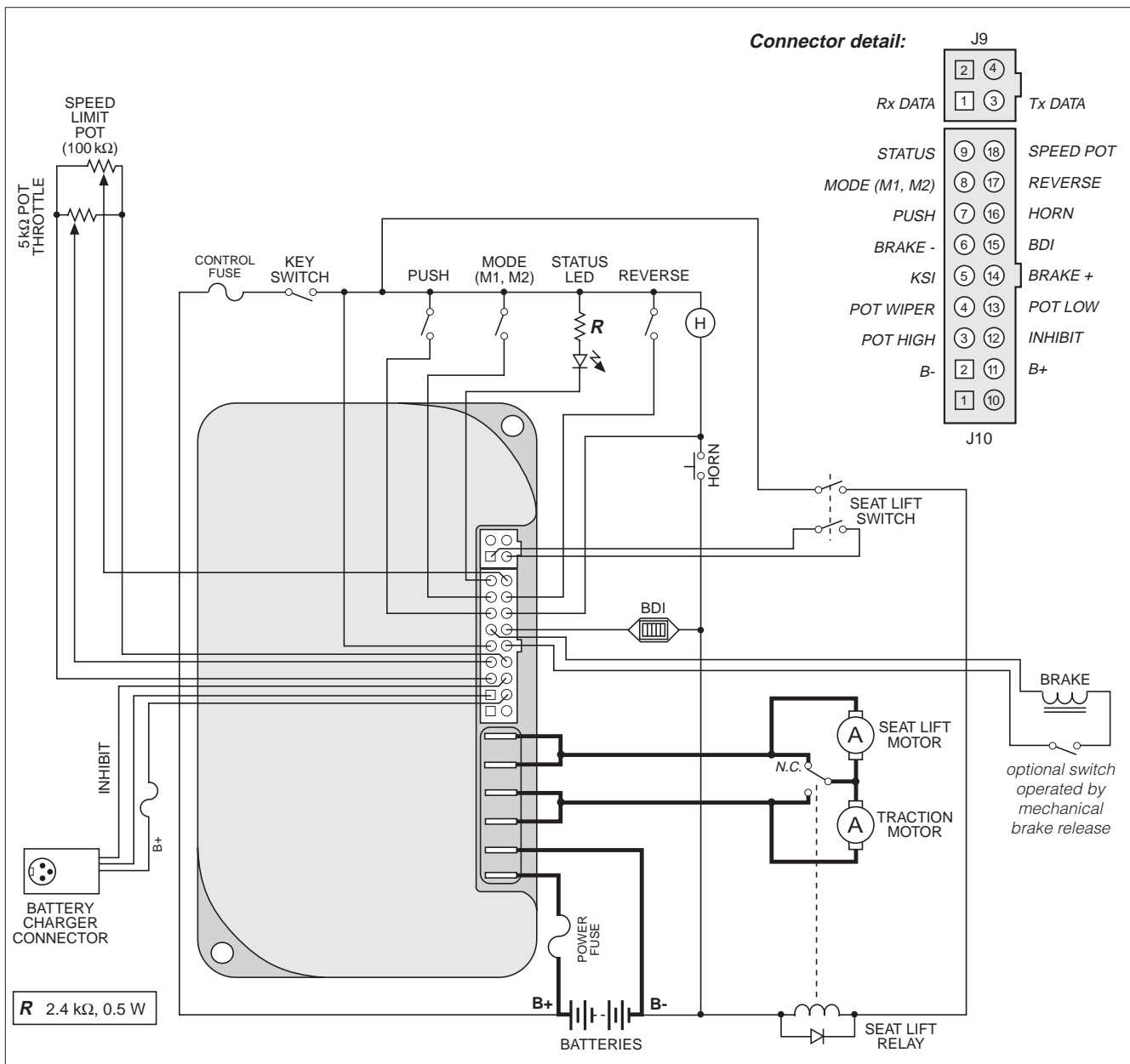

Fig. 3a Standard wiring configuration, Curtis 1228 controller.

The wiring diagram presented in Figure 3b illustrates an alternative wiring that can be used in some applications. Here the control circuit is connected to the B+ and B- pins (in this example, Pins 1 and 10) instead of to the battery pack. All four of the B+ and B- pins (Pins 1, 2, 10, 11) are connected internally to the controller's B+, B- terminals. The pins are rated at 9 amps, so this configuration is appropriate only for applications where accessory power drawn from these pins will never exceed 9 amps.

Note: When using the B+ pins (10, 11) an appropriately sized fuse must be added to the circuit to avoid damage to the controller.

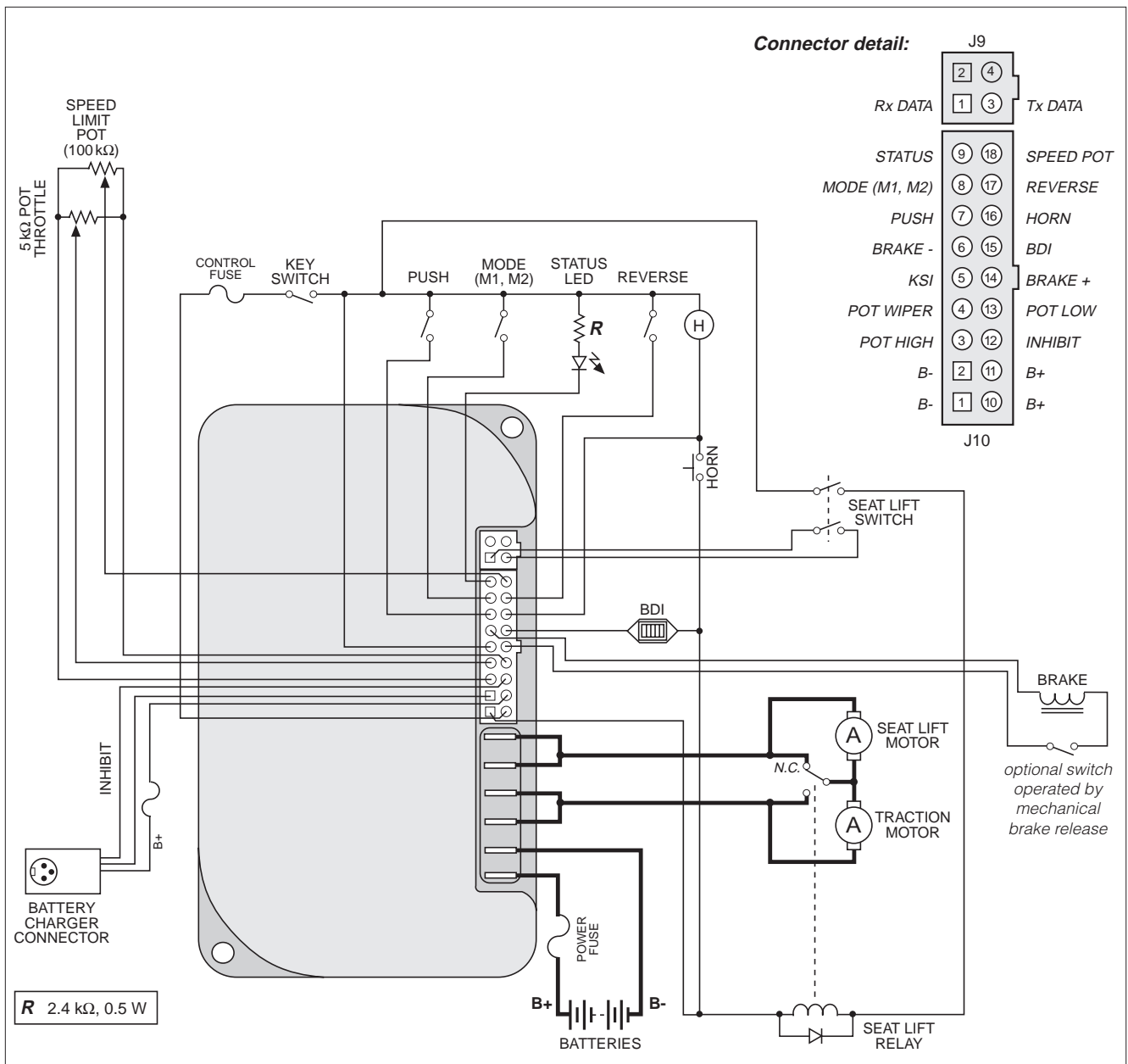

Fig. 3b Alternative wiring configuration, for low keyswitch current ($\leq 9 A$) applications.

Applications without Seat Lift Feature

The wiring presented in Figures 4a and 4b is the same as in Figures 3a and 3b, except the components and wiring used to implement the seat lift feature have been removed. This simpler configuration is applicable to vehicles such as sweepers/scrubbers and scooters that do not have seat lift motors.

This installation includes a single-ended, 3-wire 5k Ω potentiometer throttle, which is used with a reverse switch. With a wigwag throttle, a reverse switch is not used and Pin 17 is left unconnected.

In this example, one set of B+/B- pins is left unused because the logic circuit is wired directly to the vehicle's battery pack.

Note: When using the B+ pins (10, 11) an appropriately sized fuse must be added to the circuit to avoid damage to the controller.

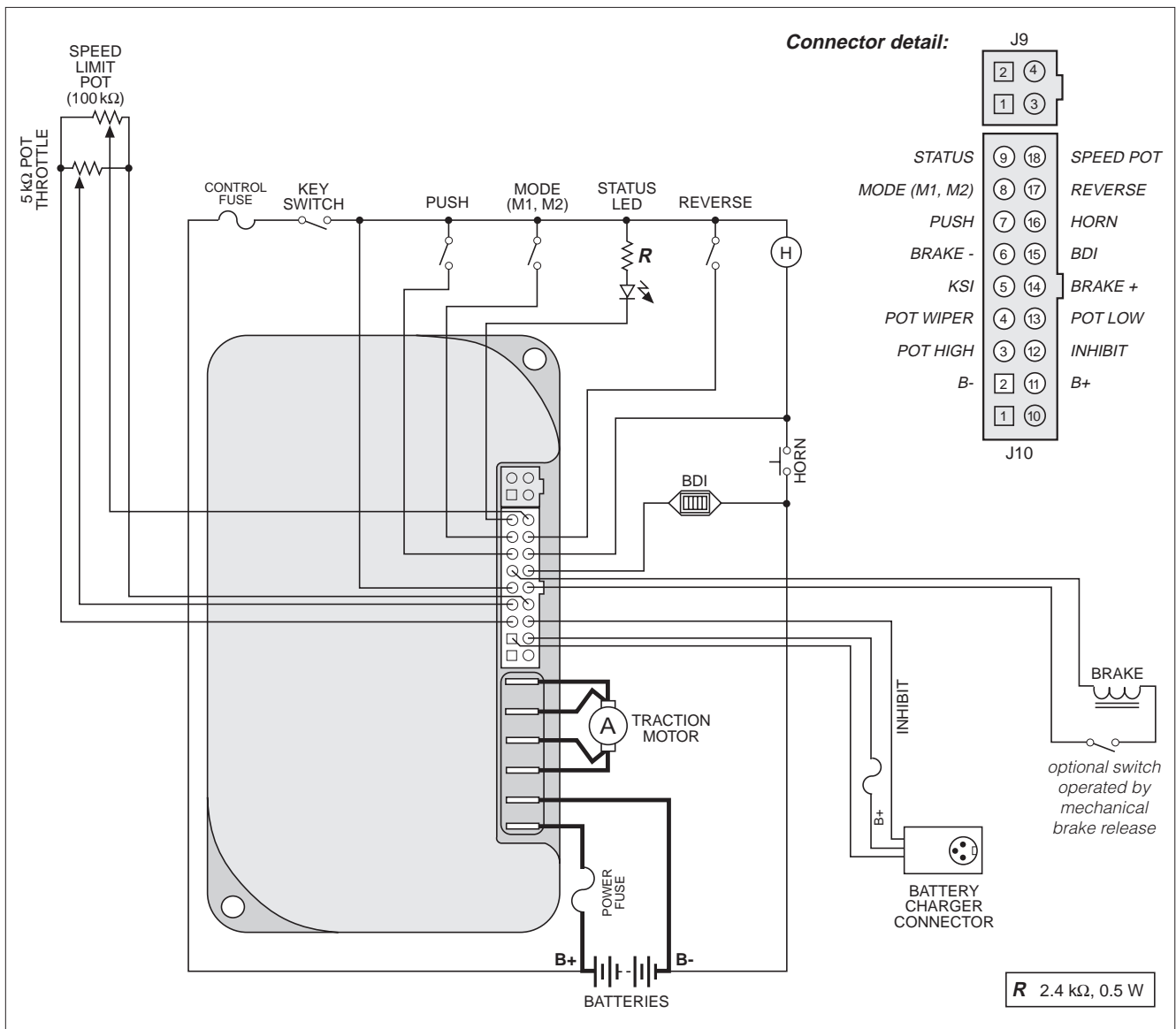

Fig. 4a Standard wiring configuration, Curtis 1228 controller, in applications with no seat lift.

The wiring diagram presented in Figure 4b illustrates an alternative wiring that can be used in some applications. Here the control circuit is connected to the B+ and B- pins (in this example, Pins 1 and 10) instead of to the battery pack. All four of the B+ and B- pins (Pins 1, 2, 10, 11) are connected internally to the controller's B+ and B- terminals. The pins are rated at 9 amps, so this configuration is appropriate only for applications where accessory power drawn from these pins will never exceed 9 amps.

Note: When using the B+ pins (10, 11) an appropriately sized fuse must be added to the circuit to avoid damage to the controller.

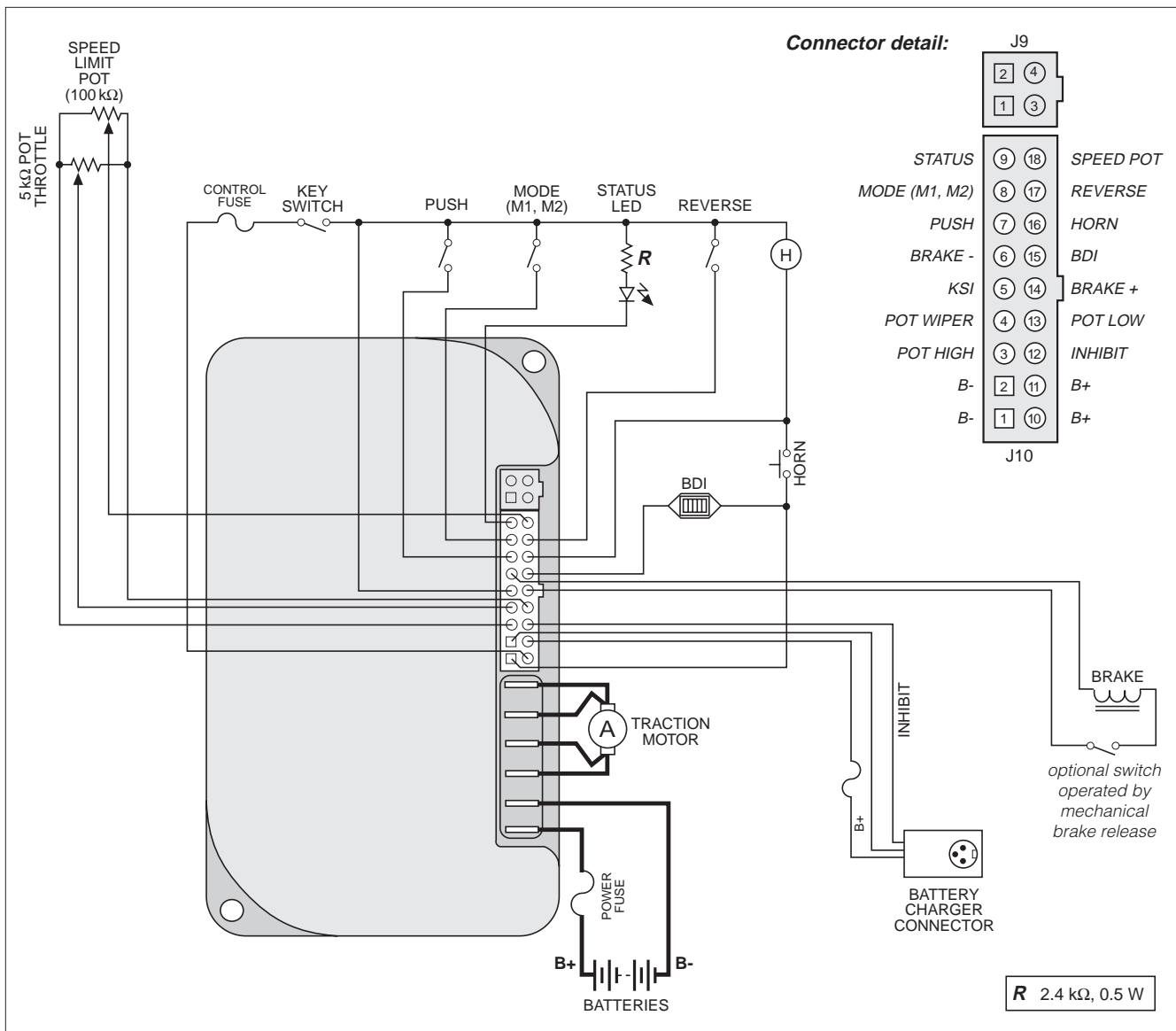

Fig. 4b Alternative wiring configuration, for low keyswitch current ($\leq 9 A$) applications, with no seat lift.

THROTTLE WIRING

A 3-wire potentiometer throttle or a voltage throttle can be used. The 1228 controller can accept a single-ended, inverse single-ended, wigwag, or inverse wigwag input signal from the throttle, depending on how the Throttle Type parameter is programmed; see page 22.

Wiring for the 3-wire pot, voltage throttle, and Curtis ET-XXX electronic throttle is described in the following text. If the throttle you are planning to use is not covered, contact the Curtis office nearest you.

5k Ω , 3-Wire Potentiometer

A 5k Ω , 3-wire potentiometer is the standard throttle, and is shown in the basic wiring diagrams (Figures 3a/3b and 4a/4b) as well as in Figure 5. With this throttle, the controller can be programmed for a Type 0, 1, 2, or 3 input signal; see page 22.

Fig. 5 *Wiring for 3-wire, 5k Ω potentiometer throttle.*

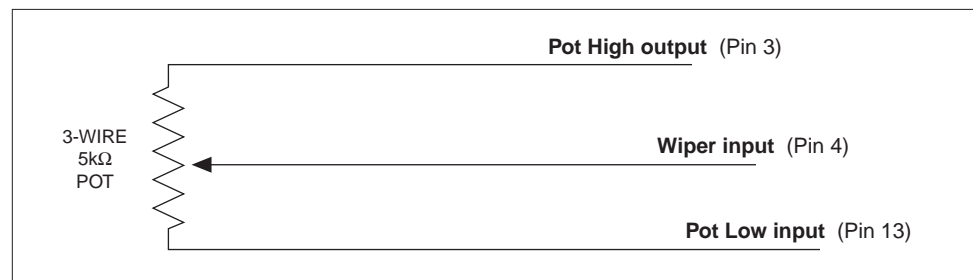

For wigwag and inverted wigwag applications, the pot can be correctly centered within the controller's neutral band by using the throttle autocalibration feature (see page 23). Pots with less than 5 k Ω total resistance change over the throttle's full stroke can be accommodated by programming the controller for reduced-range throttle inputs, via the throttle gain parameter (see page 25).

The controller provides full pot fault protection against open or shorted wires anywhere in the throttle assembly. The overall pot resistance can range from 4.5 k Ω to 7 k Ω . Values outside this range will trigger a fault condition. If a pot fault occurs while the vehicle is moving, the controller will decelerate the vehicle to neutral through its normal deceleration curve. If the fault is corrected while the throttle is still applied, the vehicle will accelerate to the requested speed.

5V Throttle

A 5V throttle can be used instead of a pot, as shown in Figure 6. With this throttle, the controller can be programmed for a Type 0, 1, 4, or 5 input signal; see page 22.

With a wigwag or inverted wigwag input, the throttle output voltage must be 2.5 V (\pm deadband) in neutral and a 4.7k Ω , 0.25W resistor must be added between the pot high and pot low pins. A resistor is not required with a single-ended input.

Fig. 6 *Wiring for 5V throttle.*

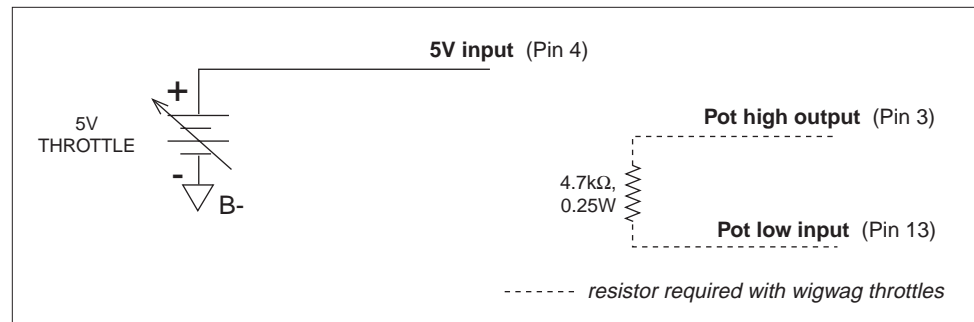

Voltage throttles with less than 5 V total voltage change over the full stroke can be accommodated by programming the controller for reduced-range throttle inputs, via the throttle gain parameter (see page 25).

Because the throttle input voltage is referenced to B- and no throttle connections are made to the pot high and pot low pins, throttle fault protection is lost with 5V throttles. The controller will not recognize out-of-range throttle inputs as faults, and applying excessive voltages to the throttle wiper input may damage the controller. **It is the responsibility of the vehicle manufacturer to provide throttle fault detection for 5V throttles.**

Curtis ET-XXX Electronic Throttle

The recommended wiring for the Curtis ET-XXX electronic throttle is shown in Figure 7. The ET-XXX throttle provides a single-ended 0–5V throttle signal and a signal indicating whether it is in forward or reverse. The controller must be programmed as a Type 4 throttle for use with the ET-XXX (see page 22).

As with any voltage throttle, there is no fault detection built into the ET-XXX. **It is the responsibility of the vehicle manufacturer to provide throttle fault detection when using the ET-XXX.**

Fig. 7 *Wiring for Curtis ET-XXX electronic throttle.*

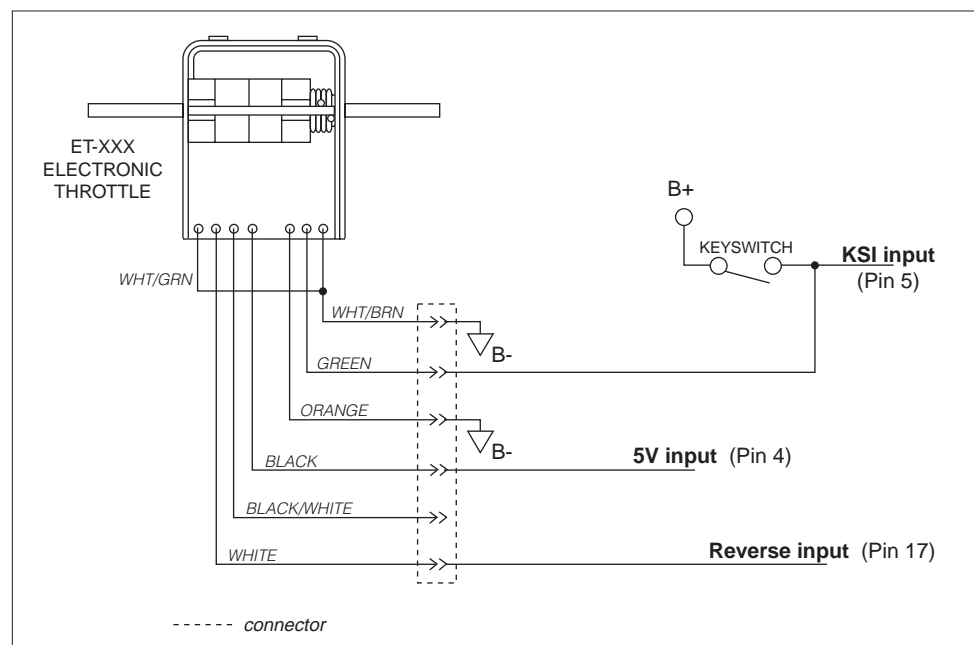

Speed Limit Pot

A speed limit pot allows the operator to adjust the speed of the vehicle at full throttle. The speed limit pot should be sized so that it does not affect throttle input resistance and thus the throttle response; a 100k Ω pot is recommended. Wiring is shown in the basic wiring diagrams (Figures 3a/3b and 4a/4b).

The speed limit pot is at its maximum speed setting when its wiper is shorted to the throttle pot's pot high connection (Pin 3). When the speed limit pot is in its maximum speed position, the vehicle's speed at full throttle corresponds to the programmed maximum speed setting.

The speed limit pot is at its minimum speed setting when its wiper is shorted to the throttle pot's pot low connection (Pin 13). When the speed limit pot is in its minimum speed position, the vehicle's speed at full throttle corresponds to the programmed minimum speed setting. For information on the programmable speed parameters, see Section 3.

The speed limit pot varies the vehicle's speed linearly over the range between the minimum and maximum speed settings in each mode.

The speed limit pot also limits the vehicle's reverse speed. Reverse speed is linearly proportional to the speed limit pot setting and is adjustable from the programmed maximum reverse speed (maximum reverse speed with speed limit pot in its maximum speed position) to the programmed minimum reverse speed (maximum reverse speed with speed limit pot in its minimum speed position).

If a speed limit pot is not used, the speed limit input (Pin 18) should be jumpered to the pot high output (Pin 3). In this configuration, the vehicle speed at full throttle is defined by the programmed maximum speed. If no jumper is used, the vehicle speed at full throttle will be limited to the programmed minimum speed, and the controller will register a speed limit pot fault.

SWITCHES AND OTHER HARDWARE

Keyswitch

The vehicle should have an OEM-supplied master on/off switch to turn the system off when not in use. The keyswitch provides logic power for the controller and for the other control input switches. It must be sized to carry the 150 mA quiescent logic current plus the current necessary to drive the precharge function (1.5 A for 0.5 seconds) and the status LED, horn, and any other accessories powered from the keyswitch circuit.

Push Switch

A push switch can be used to electrically release the electromagnetic brake, so that the vehicle can be pushed. Activating the push input inhibits the controller's drive functions until the push switch is turned off.

The push switch must go from off to on while the vehicle is stopped; if the push switch is turned on while the vehicle is moving, the electromagnetic brake

will not release when the vehicle stops. Also, the controller must be connected to the batteries and the keyswitch must be turned on in order for the push feature to be used.

Brake Release Switch (Brake Coil Disable Switch)

If a brake release lever is used to release the electromagnetic brake mechanically, a brake coil disable switch is recommended. This switch opens the electromagnetic brake coil circuit when the mechanical brake release lever releases the brake from the motor shaft. The open brake coil circuit will register as a fault, inhibiting controller operation if an operator attempts to drive the vehicle with the brake mechanically released. This safety feature ensures that the vehicle cannot be driven when the brake cannot be engaged.

Inhibit

The inhibit input can be used to inhibit operation during battery charging. The inhibit input overrides all other controller inputs and is active when low (i.e., when shorted to B-). The input can be left floating when not engaged; it does not need to be pulled high. Typically, battery chargers have a dedicated third terminal that automatically provides inhibit. If your battery charger does not have this third terminal, inhibit can be wired as shown in Figure 8.

The battery charger should only be connected after the vehicle has come to a complete stop.

Fig. 8 *Wiring to inhibit operation during battery charging (for battery chargers without a dedicated inhibit terminal).*

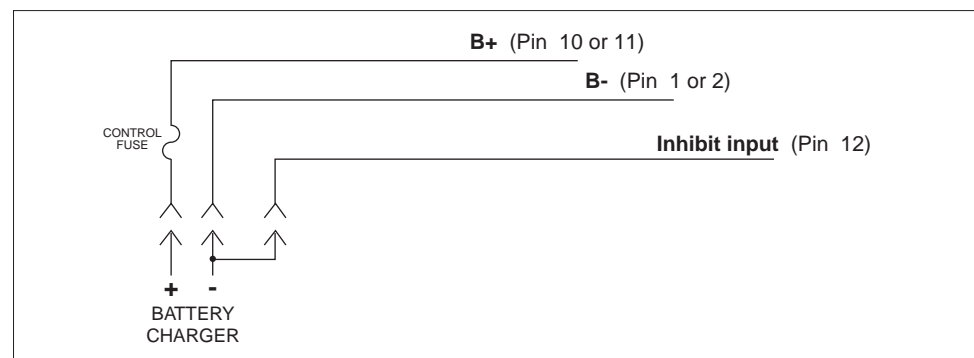

Status LED

The 1228 controller has the capability to drive a panel indicator LED, which can be used to tell the operator, at a glance, the controller's status. This LED always indicates whether the controller is powered on or off. The status LED will also provide diagnostics information via flash codes (see Section 7).

If a status LED is used, it should be installed with the proper resistor in series. The controller's LED driver is capable of a maximum current of 15 mA. The recommended resistor—designed to limit driver current to 15 mA when active—is 2.4 k Ω , 0.5 W. Alternatively, an LED with a built-in resistor can be used; it should be rated for 24V or 36V operation, depending on the controller model.

Battery Discharge Indicator (BDI)

The 1228 controller can drive a 0–5V panel meter to show the battery pack's state of charge as a percentage of the amp-hour capacity of the batteries. The BDI resets to full charge when the battery voltage rises above the programmed threshold value (see page 31). The batteries must be put through a full charge cycle with the controller installed before the BDI will begin operation.

The controller must be powered on for the BDI to monitor battery charging. One way to do this is by turning on the keyswitch. Alternatively, the controller can be factory-configured with the BDI output “stuffed” to automatically power up the controller during charging. With this option, you don't run the risk of forgetting to turn on the keyswitch and thus not getting accurate information from the BDI. Note: In order for the stuffed BDI output to power up the controller, the charger must be connected to the inhibit input; see page 13.

Horn

The controller's horn driver—Pin 16—is designed to drive a low current dc horn at 1 Hz. The horn sounds a warning when the reverse direction is selected (a series of beep tones) and when the throttle autocalibration feature is being used (a constant tone). The horn driver sinks a maximum current of 15 mA. Using a horn with a higher current requirement will damage and disable the driver.

Circuitry Protection Devices

To protect the control wiring from accidental shorts, a low current fuse (appropriately sized for the maximum control circuit current draw) should be connected in series with the B+ logic supply. A fuse is also recommended for use in the high power connection from the battery to the controller's B+ terminal. This fuse will protect the power system from external shorts and should be sized appropriately for the maximum rated current of the controller.

Seat Lift Switch

A seat lift switch can be used to short Pins 1 and 3 of the 4-pin connector (J9), thus activating the throttle-controlled seat lift function. The mating connector for J9 is a 4-pin Molex Mini-Fit Jr., p/n 39-01-2045.

Seat lift should not be turned on while the vehicle is moving.

3

PROGRAMMABLE PARAMETERS

The 1228 controller has a number of parameters that can be programmed by means of the handheld programmer. These programmable parameters allow the vehicle's performance characteristics to be customized to best fit the needs of individual vehicle operators. For information on programmer operation, see Appendix B.

The MultiMode™ feature of the 1228 controller allows operation in two distinct modes: “Mode 1” and “Mode 2.” These modes can be programmed to provide two different sets of operating characteristics, which can be useful for operation in different conditions. For example, Mode 1 could be programmed such that the vehicle moves slowly for precise, indoor maneuvering and Mode 2 programmed for higher speed, long distance travel outdoors. Three parameters can be configured independently in the two modes:

M1 maximum speed

M2 maximum speed

M1 minimum speed

M2 minimum speed

M1 maximum reverse speed

M2 maximum reverse speed.

The controller is in Mode 2 when the mode switch is in the On position (input connected to B+). Leaving the mode input floating or actively switching it Off (pulling it to B-) puts the controller in Mode 1.

Motor Parameters p. 17

Main Current Limit
Motor Resistance

Acceleration Parameters p. 17

Max-Speed Forward Accel Rate
Min-Speed Forward Accel Rate
Max-Speed Reverse Accel Rate
Min-Speed Reverse Accel Rate
Gear Soften
Soft Start

Braking Parameters p. 19

Max-Speed Forward Decel Rate
Min-Speed Forward Decel Rate
Emergency Stop Decel Rate
Max-Speed Reverse Decel Rate
Min-Speed Reverse Decel Rate
Key-Off Decel Rate
Brake Delay

Speed Parameters p. 20

Max Speed, M1/M2
Min Speed, M1/M2
Max Reverse Speed, M1/M2
Min Reverse Speed
Creep Speed
Push Speed
IR Compensation
Speed Scaler

Throttle Parameters p. 22

Throttle Input Signal Type
Throttle Autocalibration
Throttle Deadband
Throttle Gain
Ramp Shape (Static Throttle Map)

Fault Parameters p. 27

High Pedal Disable (HPD)
Brake Faults
Seat Lift Brake Faults
Fault Beep

Other Parameters p. 28

Seat Lift
Virtual Seat Lift
Beeper Solid
Ampere Hours
BDI Full Voltage
BDI Empty Voltage
BDI Reset Voltage
Sleep Delay
Tremor Compensation



Individual parameters are described in the following text in the order they are listed on this page. They are listed by the abbreviated names that are displayed in the programmer's Program Menu. Not all of these parameters are displayed on all controllers; the list for any given controller depends on its specifications.

The programmer displays the parameters in a different order. For a list of the individual parameters in the order in which they appear in the Program Menu, see Section 6: Programmer Menus.

Motor Parameters

MAIN C/L

The **main current limit** parameter allows adjustment of the maximum current the controller will supply to the motor during both drive and regenerative braking operation. This parameter can be limited to protect the motor from excessive (potentially damaging) currents or to reduce the maximum torque applied to the drive system by the motor. It is adjustable from 30 amps to 100% of the controller's full rated current. (The full rated current depends on the controller model; see 15-second ratings in Table D-1.)

MOTOR R

The **motor resistance** parameter is crucial to proper vehicle operation. The control system performance depends on this value being set correctly. The motor resistance parameter is adjustable between 0 and 625 milliohms. It must be set to the actual cold motor resistance. For instructions, see initial setup procedure ④, on page 33.

Acceleration Parameters

ACCEL MAX SPD

The **maximum-speed forward acceleration rate** defines the time it takes the controller to accelerate from zero to 100% output during forward travel at full throttle with the speed limit pot in its maximum speed position. Larger values represent a longer acceleration time and gentler starts, while smaller values represent faster acceleration. The maximum-speed forward acceleration rate is adjustable from 0.2 to 4.0 seconds. Acceleration rates under 0.5 second provide abrupt acceleration and should only be used under special circumstances.

The maximum-speed and minimum-speed forward acceleration rates are scaled linearly to provide appropriate response throughout the speed limit pot's range.

ACCEL MIN SPD

The **minimum-speed forward acceleration rate** defines the time it takes the controller to accelerate from zero to 100% output during forward travel at full throttle with the speed limit pot in its minimum speed position. Larger values represent a longer acceleration time and gentler starts, while smaller values represent faster acceleration. The minimum-speed forward acceleration rate is adjustable from 0.2 to 8.0 seconds. Acceleration rates under 0.5 second provide abrupt acceleration and should only be used under special circumstances.

REV ACCEL MAX

The **maximum-speed reverse acceleration rate** defines the time it takes the controller to accelerate from zero to 100% output while traveling in reverse at full throttle with the speed limit pot in its maximum speed position. Larger values represent a longer acceleration time and gentler starts, while smaller values represent faster acceleration. The maximum-speed reverse acceleration rate is adjustable from 0.2 to 8.0 seconds. Acceleration rates under 0.5 second provide abrupt acceleration and should only be used under special circumstances.

The maximum-speed and minimum-speed reverse acceleration rates are scaled linearly to provide appropriate response throughout the speed limit pot's range.

REV ACCEL MIN

The **minimum-speed reverse acceleration rate** defines the time it takes the controller to accelerate from zero to 100% output while traveling in reverse at full throttle with the speed limit pot in its minimum speed position. Larger values represent a longer acceleration time and gentler starts, while smaller values represent faster acceleration. The minimum-speed reverse acceleration rate is adjustable from 0.2 to 8.0 seconds. Acceleration rates under 0.5 second provide abrupt acceleration and should only be used under special circumstances.

GEAR SOFTEN

The **gear soften** feature allows smooth pickup of gear slack in the transmission when torque is reversed; it affects all accelerations except those from zero speed. The effect of this feature is most noticeable when reapplying the throttle from neutral after decelerating from high speed but before coming to a stop. (See soft start parameter, below, for softening torque endpoints for accelerations from a complete stop.)

The gear soften parameter is adjustable from 0% to 100%, with 100% providing a great deal of softening and 0% eliminating the feature. The trade-off in increasing the gear soften value is that acceleration response may be slowed somewhat, especially at higher values.

SOFT START

The **soft start** feature allows softened torque endpoints for forward/reverse accelerations from a complete stop. When accelerating from a stop, some users prefer the softened gear slack transitions this parameter can provide, while others prefer the vehicle to respond instantly.

The soft start parameter is adjustable from 0% to 100%, with 100% providing a great deal of softening and 0% eliminating the feature. The trade-

off in increasing the soft start value is that acceleration response may be slowed somewhat, especially at higher values.

Braking Parameters

DECEL MAX SPD

The **maximum-speed forward deceleration rate** determines the time it takes the controller to decelerate from its present output to zero when the throttle is released to neutral during forward travel with the speed limit pot in its maximum speed position. Larger values represent a longer deceleration time and gentler stops. Smaller values will reduce the stopping distance required. The maximum-speed deceleration rate should be set at a value that will ensure the vehicle stops within a safe distance when traveling at full speed. The maximum-speed deceleration rate is adjustable from 0.2 to 4.0 seconds. Deceleration rates under 0.5 second provide abrupt stops and should only be used under special circumstances.

DECEL MIN SPD

The **minimum-speed forward deceleration rate** defines the time it takes the controller to decelerate from its present output to zero when the throttle is released to neutral during forward travel with the speed limit pot in its minimum speed position. Larger values represent a longer deceleration time and gentler stops. Smaller values will reduce the stopping distance required. The minimum-speed deceleration rate is adjustable from 0.2 to 8.0 seconds. Deceleration rates under 0.5 second provide abrupt stops and should only be used under special circumstances.

E STOP

The **emergency stop deceleration rate** defines the time it takes the vehicle to stop when a reverse throttle command >80% is given while the vehicle is moving forward. This gives the operator a way to stop more quickly when unexpected conditions arise.

When the E Stop feature is invoked the E Stop deceleration rate becomes the new forward deceleration rate. Therefore it makes sense to set it to a value lower (faster stop) than the fastest forward deceleration rate (DECEL MAX SPEED). The E Stop deceleration rate is adjustable from 0.2 to 4.0 seconds.

REV DECEL MAX

The **maximum-speed reverse deceleration rate** defines the time it takes the controller to decelerate from its present output to zero when the throttle is released to neutral during reverse travel with the speed limit pot in its maximum speed position. Larger values represent a longer deceleration time and gentler

stops. Smaller values will reduce the stopping distance required. The maximum-speed reverse deceleration rate should be set at a value that will ensure the vehicle stops within a safe distance when traveling in reverse at full speed. The maximum-speed deceleration rate is adjustable from 0.2 to 4.0 seconds. Deceleration rates under 0.5 second provide abrupt stops and should only be used under special circumstances.

REV DECEL MIN

The **minimum-speed reverse deceleration rate** defines the time it takes the controller to decelerate from its present output to zero when the throttle is released to neutral during reverse travel with the speed limit pot in its minimum speed position. Larger values represent a longer deceleration time and gentler stops. Smaller values will reduce the stopping distance required. The minimum-speed reverse deceleration rate is adjustable from 0.2 to 8.0 seconds. Deceleration rates under 0.5 second provide abrupt stops and should only be used under special circumstances.

KEY OFF DECEL

The **key-off deceleration rate** defines the time it takes the vehicle to stop after the keyswitch has been turned off while the vehicle is in motion. The key-off deceleration rate is independent of the normal programmed deceleration rate, the selected mode, and the speed and direction of travel when KSI is switched off. It is adjustable from 0.2 to 4.0 seconds.

BRAKE DELAY

The **brake delay** parameter specifies when the controller engages the electromagnetic brake after the vehicle's speed command has reached zero. This time delay is adjustable from 0.0 to 1.0 seconds. It should be set low enough to minimize rolling downhill when stopping on ramps, yet long enough to allow for a smooth stop on flat surfaces.

The brake delay does not apply in situations where an incline causes the vehicle to change direction after the throttle command has been zeroed. In this case, the controller will detect the "rollback" and engage the electromagnetic brake immediately.

Speed Parameters

M1/M2 MAX SPD

The **maximum speed** parameter defines the maximum allowed speed at full forward throttle with the speed limit pot in its maximum speed position. For example, if Mode 1 Maximum Speed is set at 60% and the speed limit pot is in its maximum speed position, the controller will adjust its output to achieve

60% speed at full throttle in Mode 1. Note: If a speed limit pot is not used in your application, see page 12.

M1/M2 MIN SPD

The **minimum speed** parameter defines the maximum allowed speed at full forward throttle with the speed limit pot in its minimum speed position. For example, if Mode 1 Minimum Speed is set at 20% and the speed limit pot is in its minimum speed position, the controller will adjust its output to achieve 20% speed at full throttle in Mode 1. The minimum speed cannot be set higher than the programmed maximum speed. Note: If a speed limit pot is not used in your application, see page 12.

M1/M2 REV MAX SPD

The **maximum reverse speed** parameter defines the maximum allowed speed in reverse at full throttle with the speed limit pot in its maximum speed position. For example, if Mode 1 Maximum Reverse Speed is set at 40% and the speed limit pot is in its maximum speed position, the controller will adjust its output to achieve 40% reverse speed at full throttle in Mode 1. Note: If a speed limit pot is not used in your application, see page 12.

REV MIN SPD

The **minimum reverse speed** parameter defines the maximum allowed speed in reverse at full throttle with the speed limit pot in its minimum speed position. Reverse speed is not affected by which mode (Mode 1, Mode 2) is selected. Note: If a speed limit pot is not used in your application, see page 12.

CREEP SPD

Creep speed helps to prevent vehicle rollback on inclines when the brake is released with very little throttle applied. It is activated when the throttle request exceeds the throttle's deadband threshold. The throttle response is rescaled so that the controller's output is adjustable over the full throttle range, but starting at the programmed creep speed value. Creep speed is programmable from 0% to 10.0% of the maximum available speed.

PUSH SPD

When the push switch is switched to the On position, the push feature releases the electromagnetic brake and allows the vehicle to be manually pushed. The maximum speed at which the vehicle can be pushed is defined by the **push speed** parameter. It is programmable from 25% to 50% of the maximum available speed. This parameter also sets the "push-too-fast" speed, which is the maximum speed at which the vehicle can be pushed when it is unpowered and the brake is mechanically released. Note: the vehicle must be manually pushed

fast enough so that the motor voltage reaches approximately 15 V in order for the push feature to be activated.

IR COMP COEFF

IR compensation is a method by which the controller maintains a constant vehicle speed despite changes in motor loading. The **IR compensation** parameter adjusts how aggressively the controller tries to maintain constant speed under changing load conditions. The parameter is scaled 0–100%, and defines the percentage of compensation applied.

SPD SCALER

The **speed scaler** parameter sets the maximum voltage that can be applied to the motor. It can be used to eliminate variations in maximum speed that would otherwise result when driving with a fully charged battery vs. a partially discharged battery. If the speed scaler is set at 23 volts, for example, the maximum vehicle speed will be the same whether the actual battery voltage is 28 volts or 23 volts or any value in between.

The speed scaler parameter is programmable between 20.0 V and 28.0 V.

Throttle Parameters

THRTL TYPE

The controller can be programmed to accept single-ended, wigwag, or inverted wigwag signals from a 5k Ω , 3-wire pot or from a 5V throttle.

The **throttle input signal type** options—Types “0” through “5” in the Throttle Type programming menu—are listed in Table 1.

THROTTLE TYPE	APPLICABILITY		DESCRIPTION
	5k Ω 3-wire Pot	5V Throttle	
0	✓	✓*	wigwag pot or voltage throttle
1	✓	✓*	inverted wigwag pot or voltage throttle
2	✓		single-ended pot; maximum speed = 5k Ω
3	✓		inverted single-ended pot; maximum speed = 0
4		✓	single-ended voltage throttle; maximum speed = 5V
5		✓	inverted single-ended voltage throttle; maximum speed = 0

* Requires resistor; see Figure 6, page 11.

THRTL AUTOCAL

The **throttle autocalibration** parameter provides a means of easily and reliably centering wigwag throttle pots. To use this method, a horn must be connected to the horn driver. The controller inhibits driving while in autocalibration mode, enabling the throttle potentiometer to be adjusted safely.

Throttle centering is accomplished as follows:

1. Jack the vehicle drive wheels off the ground or disconnect the motor leads.
2. Completely assemble the throttle mechanism but do not tighten the clamping mechanism that secures the potentiometer shaft to the throttle lever.
3. Plug the programmer into the controller, and turn on the key-switch.
4. Select the program mode and scroll down to the throttle autocalibration parameter.
5. Set the throttle autocalibration to On. At this point, the horn will probably sound, indicating that the throttle pot is out of adjustment. If the horn does not sound, the pot is already centered and further adjustment is not necessary.
6. With the throttle lever at the neutral position, adjust the potentiometer in one direction until the horn turns off. Note this position. Adjust the pot in the other direction until the horn turns off. Note this position. Set the pot halfway between the two noted positions. The pot is now adjusted to the proper value for neutral.
7. Tighten the clamping mechanism that secures the throttle lever to the potentiometer shaft. Depress and release the throttle to verify the mechanical return to neutral; the horn should turn off with the same amount of motion in both directions.
8. Set the throttle autocalibration parameter to Off, or cycle the keyswitch to reset it to Off. (If you are performing the reset by cycling the keyswitch, note that KSI must remain off for at least 4 seconds.) The vehicle will not drive if the throttle autocalibration parameter is left On.

THRTL DEADBAND

The **throttle deadband** parameter defines the throttle pot wiper voltage range that the controller interprets as neutral. Increasing the throttle deadband setting increases the neutral range. This parameter is especially useful with throttle assemblies that do not reliably return to a well-defined neutral point, because it allows the deadband to be defined wide enough to ensure that the controller goes into neutral when the throttle mechanism is released.

Examples of two deadband settings (25%, 10%) are shown in Figure 9, along with the equations used to determine the wiper voltage range (with respect to B-) that the controller will interpret as neutral.

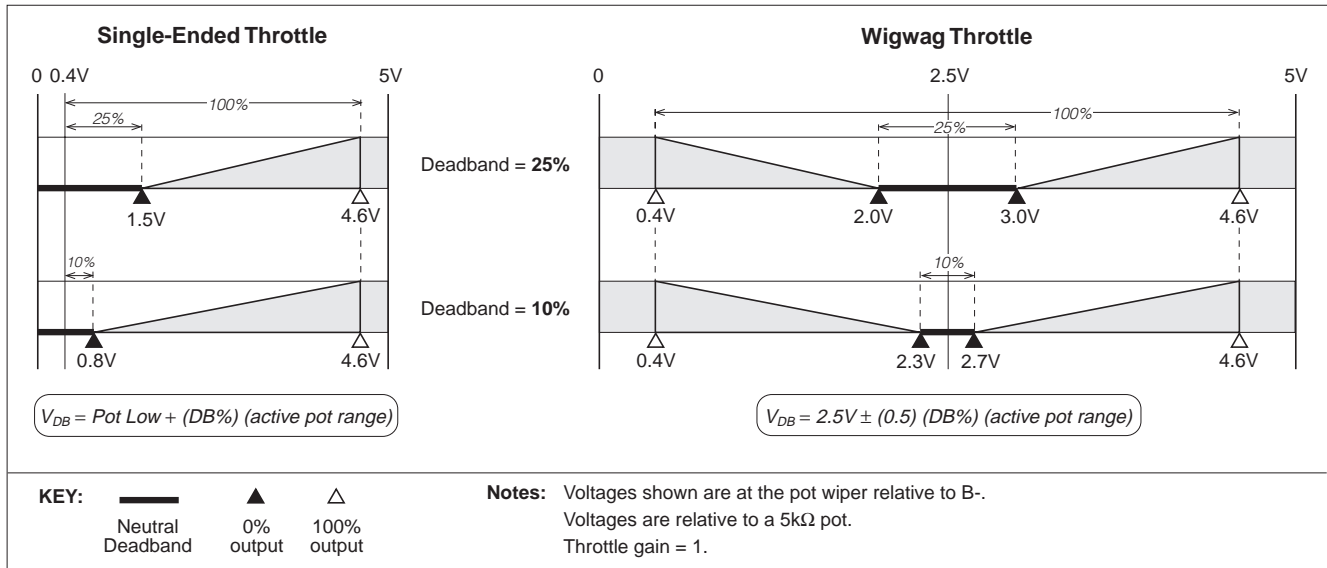

Fig. 9 Effect of adjusting the throttle deadband parameter.

The programmer displays the throttle deadband parameter as a percentage of the wiper voltage range and is adjustable from 6.0% to 25.0%. The default deadband setting is 10.0%.

The throttle wiper voltage range is approximately 4 volts, measured relative to B-. This is true regardless of whether a single-ended or wigwag throttle is used. When a single-ended throttle is used, the deadband parameter sets a single threshold wiper voltage—that is, a wiper voltage (relative to B-) at which the controller will begin to modulate. When a wigwag throttle is used, the deadband parameter sets two threshold wiper voltages, one on either side of the 2.5 V centerpoint, for forward and reverse.

Depending on the individual pot, the values for Pot Low and Pot High (and hence for the deadband, which is a percentage of the range defined by Pot Low and Pot High) vary. The values listed below can be used with the equations provided in Figure 9 to calculate the actual deadband threshold(s) for any given deadband setting:

POT	POT LOW	POT HIGH	POT RANGE
4 kΩ	0.5 V	4.5 V	4.0 V
5 kΩ	0.4 V	4.6 V	4.2 V
7 kΩ	0.3 V	4.7 V	4.4 V

Detailed guidelines for adjusting the throttle deadband parameter are presented in Section 4.

THRTL GAIN

The **throttle gain** parameter sets the wiper voltage required to produce 100% controller output. Increasing the throttle gain setting reduces the wiper voltage required, and therefore the full stroke necessary to produce full output is reduced. This feature allows reduced-range throttle assemblies to be used.

Examples are shown in Figure 10 to illustrate the effect of three different throttle gain settings (1, 1.5, and 2) on full-stroke wiper voltage. Adjusting the throttle gain also affects the neutral deadband, which is a percentage of the throttle's active range. Note: The deadband values shown in the bottom two examples are the same due to rounding; the actual deadband in the bottom example is somewhat narrower than in the example above it.

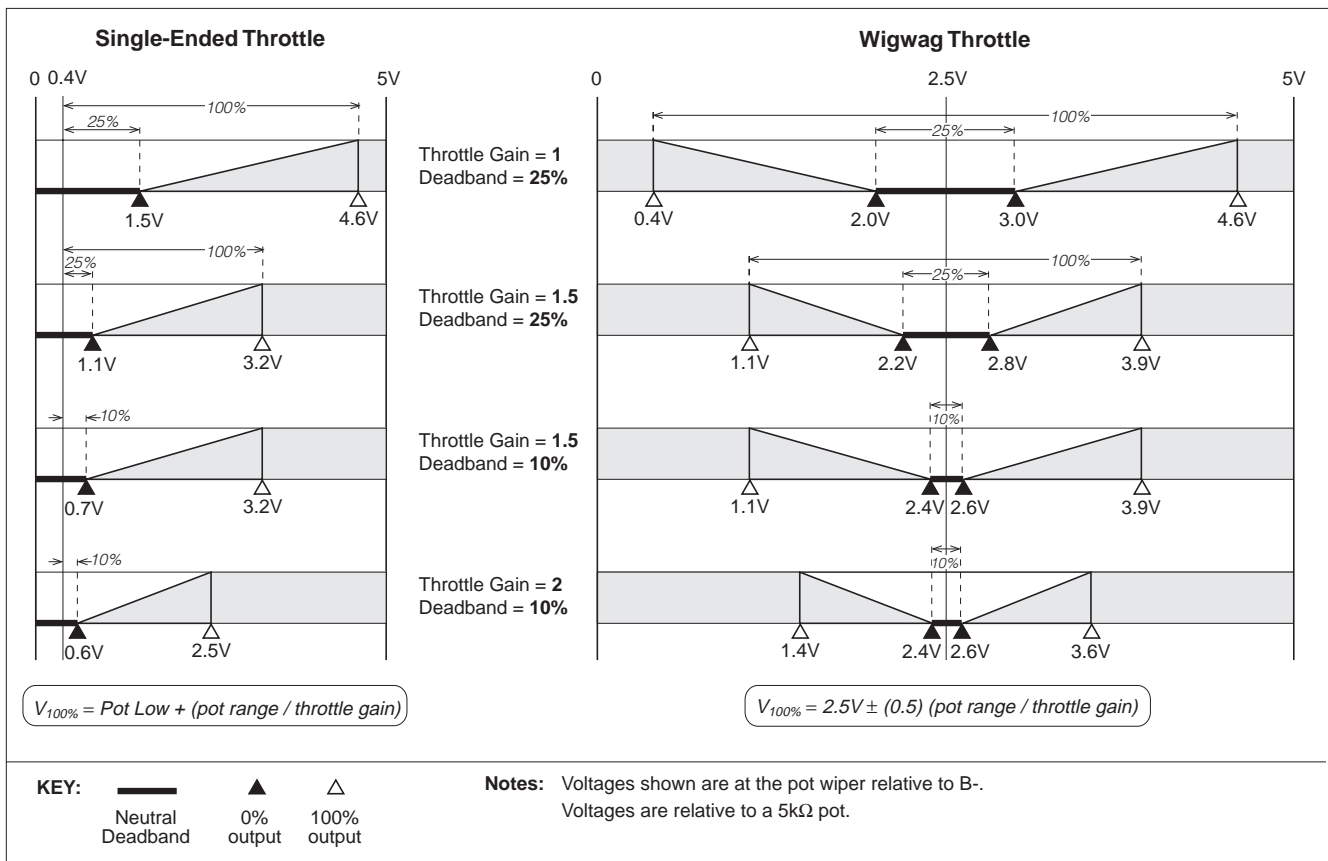

Fig. 10 Effect of adjusting the throttle gain parameter.

When a single-ended throttle is used, the throttle gain parameter sets the maximum pot wiper voltage required to produce 100% output. When a wigwag throttle is used, the throttle gain parameter sets the pot wiper resistance required to produce 100% output in both forward and reverse: the wiper voltage required for full forward output is decreased, and the wiper voltage required for full reverse output is increased.

The throttle gain parameter can be set with values from 1.0 to 10.0. The throttle gain value is the ratio of the pot's full 5kΩ to the resistance of the throttle's range of travel ($G = R_{\text{pot}} / R_{\text{travel}}$). A setting of 1.0 thus represents a one-to-one

ratio—in other words, no throttle gain adjustment. A setting of 10.0 would allow use of a pot with a range of only 1/10th of 5k Ω , i.e., 500 ohms. For most applications, throttle gain settings between 1.0 and 2.0 will work best.

Note: The throttle characteristics are defined in terms of wiper voltage rather than throttle pot resistance because of the range of pot values that can be used and the variation between pots of the same value.

Detailed guidelines for adjusting the throttle gain parameter are presented in Section 4.

RAMP SHAPE

The **ramp shape** parameter determines the static throttle map of the controller. This parameter modifies the throttle input to the controller, and hence the vehicle's response. Setting the ramp shape parameter at 50% provides a linear response to throttle position. Values below 50% reduce the throttle command at low throttle positions, providing enhanced slow speed maneuverability. Values above 50% give the vehicle a faster, jumpier feel at low throttle positions.

The ramp shape can be programmed to values between 20.0% and 70.0%. The ramp shape number refers to the throttle command at half throttle. For example, if maximum speed is set at 100%, a ramp shape of 40% will result in a 40% throttle command at half throttle. The 50% ramp shape corresponds to a linear response. Six ramp shapes (20, 30, 40, 50, 60, and 70%) are shown as examples in Figure 11.

Fig. 11 Ramp shape (throttle map) with maximum speed set at 100%.

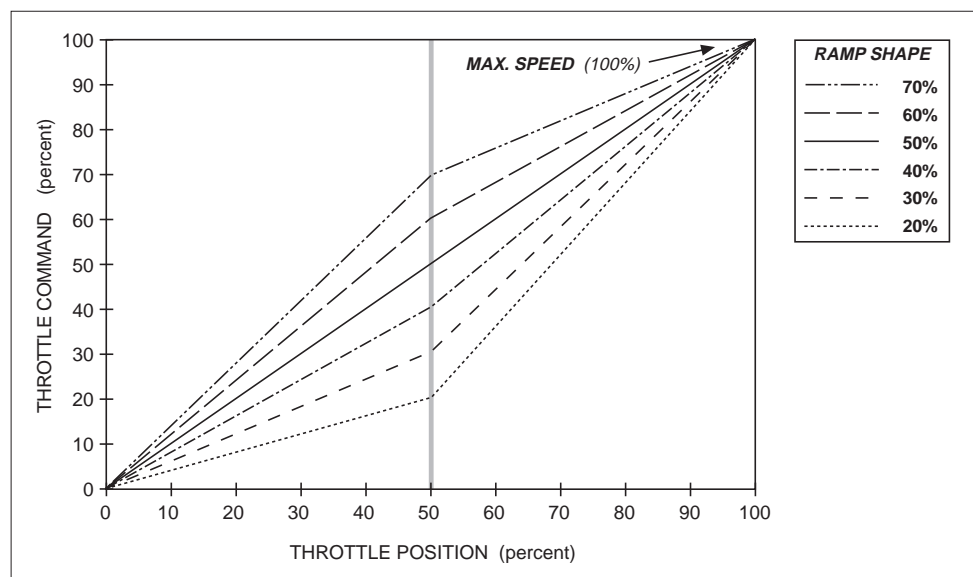

Changing the maximum speed setting changes the throttle command range, and hence the ramp shape. Ramp shapes with the maximum speed setting dropped from 100% to 60% are shown in Figure 12.

Fig. 12 Ramp shape (throttle map) with maximum speed set at 60%.

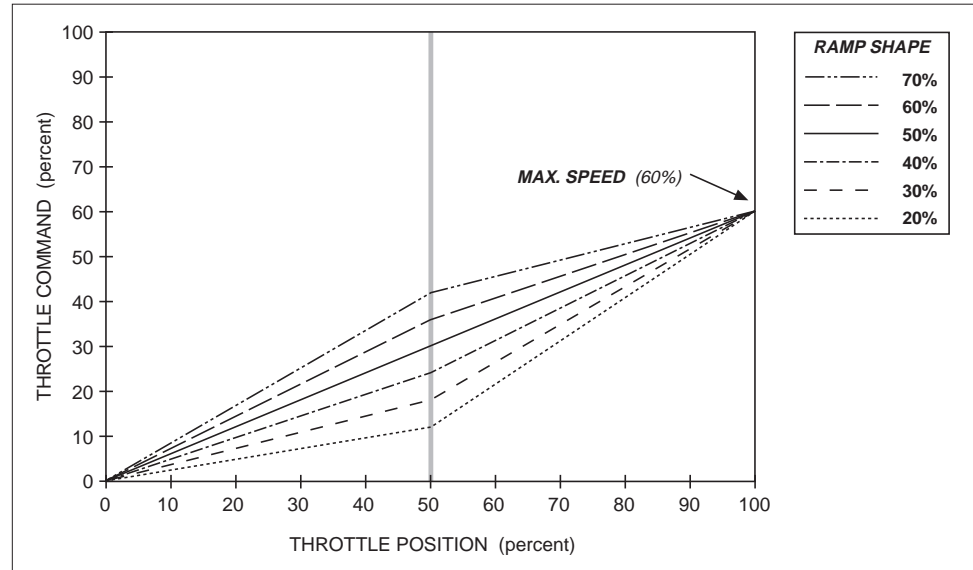

In all cases, the ramp shape number is the throttle command at half throttle. In Figure 12, for example, the 50% ramp shape results in a 30% throttle command at half throttle (i.e., a command that is halfway between 0% and 60%). The 20% ramp shape results in a 12% command at half throttle (20% of the range from 0% to 60%).

Fault Parameters

HIGH PEDAL DIS

The primary function of the **high pedal disable (HPD)** feature is to prevent the vehicle from moving if the controller is turned on with the throttle already applied. HPD also serves as the interlock to prevent the vehicle from starting up with the push or inhibit feature active, and to prevent driving if Inhibit is activated during operation.

When the HPD parameter is programmed On, HPD is active and controller output is inhibited (1) if a throttle input greater than the throttle deadband exists when the controller is turned on, (2) if the push switch is On when the controller is turned on, (3) after the vehicle reaches a stop if the push switch is activated while the vehicle is being driven, or (4) if the inhibit switch is activated while the vehicle is being driven. If HPD is programmed Off, this protection feature is disabled. Note: All DME scooter applications must have the HPD feature programmed On to satisfy the industry's safety requirements.

BRAKE FLTS

The **brake faults** parameter enables (“On”) or disables (“Off”) all the electromagnetic brake driver and wiring fault detection. All DME scooter applications must have this parameter programmed On to satisfy the industry’s safety requirements.

In non-DME applications such as sweeper/scrubbers, where there is no electromagnetic brake, the brake faults parameter can be programmed Off, thus eliminating the need for the 200 Ω , 5W bias resistor on the controller’s brake driver output that would otherwise be necessary.

SL BRAKE FLTS

The **seat lift brake faults** parameter enables (“On”) or disables (“Off”) the brake coil open and shorted brake driver fault detection in seat lift mode.

The seat lift brake faults parameter is only active when the standard brake faults parameter is also programmed On. If the standard brake faults parameter is programmed Off, there will be no fault detection in seat lift mode even if the seat lift brake faults parameter is programmed On.

Note: If you are installing the 1228 controller in an existing scooter system that uses a brake disable relay in its seat lift circuit, you should program the seat lift brake faults parameter Off. Systems designed to be used with the new 1228 do not require this second relay, which was required by earlier versions.

FAULT BEEP

The **fault beep** parameter enables the horn during controller faults, in order to make the fault codes audible. It beeps only the fault codes; it does not precede the fault code with a level-of-seriousness code (as does the status LED, with its slow/fast flash preceding the fault code). If this audible alarm is not wanted, the fault beep parameter should be programmed Off.

Other Parameters

SEAT LIFT

DME scooter systems typically use the 1228 controller to drive the seat lift motor as well as the traction motor. The power path is determined by a relay that routes motor drive power from the controller to either the traction motor or the seat lift motor depending on whether the seat lift switch is open or closed; see Figures 3a/3b. When the seat lift feature is active, the controller disables the electromagnetic brake driver (i.e., sets the brake), and operates in Mode 1, regardless of mode switch position.

The seat lift switch connector plugs into J9 (the 4-pin connector). The controller transitions from traction mode to seat lift mode when the seat lift switch is closed.

To use the programmer, you must remove the seat lift switch connector from J9 in order to plug in the programmer; both connectors use J9. When you have finished using the programmer, the seat lift switch connector can be plugged back into J9.

The **seat lift** parameter enables (“On”) or disables (“Off”) seat lift mode. Programming the seat lift parameter On enables the controller to recognize seat lift switch inputs at J9. If the seat lift parameter is programmed Off, the controller will not respond to the seat lift switch, even when it is plugged into J9.

VSL

The handheld programmer and the seat lift switch input share the same 4-pin connector (J9) on the controller—see Figures 3a/3b. The **virtual seat lift** parameter allows the controller to be put into seat lift mode when the programmer—rather than the seat lift switch input—is plugged in. Setting this parameter On transitions the controller from traction mode to seat lift mode, and sets the brake (i.e., disables the electromagnetic brake driver). This can be convenient when the programmer is being used during vehicle checkout. VSL automatically resets to Off when the keyswitch is cycled.

For controllers without the VSL parameter, seat lift operation can be tested only when the programmer is not plugged in.

BEEPER SOLID

The **beeper solid** parameter, when programmed On, provides a continuous 24V+ signal to the horn driver (Pin 16) when throttle is requested in reverse; this signal can be used to drive a logic function—such as a watering solenoid for a sweeper/scrubber.

When a horn is connected to Pin 16, the Beeper Solid parameter is typically programmed Off. With Beeper Solid programmed Off, the horn sounds a series of beep tones when throttle is requested in reverse.

This feature is available only on 1228-29XX and 1228-34XX models.

AMPERE HOURS

The **ampere hours** parameter provides a means of tailoring a battery discharge indicator (BDI) to the battery pack on a particular vehicle. The ampere hours parameter should be set to the amp-hour capacity of the battery pack.

BDI FULL VLTS

The **BDI full voltage** parameter sets the battery voltage considered to be a 100% state-of-charge. It should be set to the voltage level of the fully-charged battery pack.

BDI EMPTY VLTS

The **BDI empty voltage** parameter sets the battery voltage considered to be a 0% state-of-charge; when the battery pack remains under this voltage consistently, the BDI will read 0% state of charge. It is typically set to about 85% of BDI full voltage.

BDI RESET

The **BDI reset voltage** parameter sets the no-load threshold at which the controller's battery-state-of-charge calculator will reset to 100%. When this voltage is present for 2 minutes the battery discharge indicator (BDI) is reset to 100%. Because this is the charging voltage, it is set 2 to 3 volts higher than the actual battery voltage (e.g., 27 V for a 24V system).

SLEEP DLY

The controller powers down completely if the throttle request remains at neutral beyond the time specified by the **sleep delay** parameter; to resume operation, the keyswitch must be cycled. The sleep delay can be set from 1 to 60 minutes. Setting this parameter to zero disables the sleep delay.

TREMOR COMP

The **tremor compensation** parameter allows adjustment to limit the controller's response to sharp throttle movements, such as movements resulting from hand tremors. The tremor compensation parameter can be set to values of 1 through 5, with 1 providing no compensation, and 5 providing the most. Although larger values provide steadier response, they also result in more sluggish response to throttle requests. There is thus a trade-off between crispness of response (low tremor compensation settings) and steady speed in the presence of tremors (high tremor compensation settings).

The effect of tremor compensation is most noticeable when the throttle is moved quickly from full to very low requests. Note: this function is bypassed if the throttle moves into the neutral deadband.

Although designed primarily to help end users with hand tremor problems, this parameter can be used more generally to smooth out overall vehicle responsiveness for steadier driving.

4

INITIAL SETUP

Before operating the vehicle, carefully complete the following initial setup procedures. If you find a problem during the checkout, refer to the diagnostics and troubleshooting section (Section 7) for further information.

Before starting the setup procedures, **jack the vehicle drive wheels up off the ground so that they spin freely**. Doublecheck all wiring to ensure that it is consistent with the wiring guidelines presented in Section 2. Make sure all connections are tight.

① Begin the setup procedures

①-a. Put the throttle in neutral, and make sure the forward/reverse switches are open.

①-b. Turn on the controller and plug in the 1311 programmer. The programmer should power up with an initial display, and the status LED should light steadily. If neither happens, check for continuity in the keyswitch circuit and controller ground.

② Throttle

Put the programmer into Program mode, and set the Throttle Type parameter to match the throttle you are using (Type 0–5); see page 22.

It is important to ensure that the controller output is operating over its full range. The following tuning procedures will establish the throttle deadband and throttle gain parameter values that correspond to the absolute full range of your particular throttle mechanism.* It is advisable to include some buffer around the absolute full range of the throttle mechanism to allow for throttle resistance variations over time and temperature as well as variations in the tolerance of potentiometer values between individual throttle mechanisms.

Tuning the Throttle Deadband

②-a. Select the Test Menu. The Throttle % field should be visible in the display. You will need to reference the value displayed here..

②-b. Slowly apply the throttle until you hear the electromagnetic brake disengage. Use care with this step as it is important to identify the threshold throttle position at which the brake is disengaged.

②-c. Without moving the throttle, read the value shown in the Throttle % field. This value should be zero. If the Throttle % value is zero, proceed to Step 2-d. If it is greater than zero, the throttle deadband parameter must be increased. Select the Program Menu, scroll down to display the THRTL DEADBAND field, and enter a larger THRTL DEADBAND value. Select the Test Menu and repeat

* If you are using a wigwag throttle, you should center it before proceeding with the throttle tuning procedures. Instructions for wigwag throttle centering (using the Throttle Autocalibration parameter) are presented on page 23.

the procedure from Step 2-b until the Throttle % is zero at the electromagnetic brake disengagement point.

②-d. While observing the Throttle % value displayed in the programmer's Test Menu, continue to increase the throttle past the electromagnetic brake disengagement point. Note where the Throttle % value begins to increase, indicating that the controller has begun to supply drive power to the motor. If the throttle had to be moved further than desired before the Throttle % value began to increase, the throttle deadband parameter must be decreased. In the Program Menu, scroll down to the THRTL DEADBAND field, and enter a smaller THRTL DEADBAND value. Select the Test Menu and repeat the procedure from Step 2-b. When the amount of travel between the point at which the brake is disengaged and the Throttle % value begins to increase is acceptable, the throttle deadband is properly tuned.

②-e. If a bidirectional (wigwag) throttle assembly is being used, the procedure should be repeated for the reverse direction. The THRTL DEADBAND value should be selected such that the throttle operates correctly in both forward and reverse.

Tuning the Throttle Gain

②-f. Apply full throttle and observe the Throttle % value. This value should be 100%. If it is less than 100%, the throttle gain must be increased to attain full controller output at the maximum throttle position. Select the Program Menu, scroll down to the THROTTLE GAIN field, and enter a larger THROTTLE GAIN value. Select the Test Menu and repeat this step until the Throttle % value is 100%.

②-g. Now that the full throttle position results in a 100% value for Throttle %, slowly reduce throttle until the Throttle % value drops below 100% and note the throttle position. This represents the extra range of motion allowed by the throttle mechanism. If this range is large, you may wish to decrease it by decreasing the throttle gain. This will provide a larger active throttle range and more vehicle control. Select the Program Menu, scroll down to the THROTTLE GAIN field, and enter a smaller THROTTLE GAIN value. Select the Test Menu and repeat this step until an appropriate amount of extra range is attained.

②-h. If a wigwag throttle is being used, repeat the procedure for the reverse direction. The THROTTLE GAIN value should be selected such that the throttle operates correctly in both forward and reverse.

Confirming proper throttle operation

Select a direction and operate the throttle. The motor should begin to turn in the selected direction. If it does not, verify the wiring to the throttle and motor. The motor should run proportionally faster with increasing throttle. If not, refer to Section 7.

③ Basic vehicle checkout

Put the programmer in Test mode, and scroll down the menu to observe the status of the switches: mode, reverse, and push. Plug in the battery charger to verify the Inhibit input status. Cycle each input in turn, observing the programmer. The programmer should display the correct status for each input.

Similarly, check the throttle and speed limit pot inputs. The programmer should display the correct value for each input.

Verify that all options, such as high pedal disable (HPD) and seat lift, are as desired. To verify operation of the seat lift function, put the programmer into Program mode and set the VSL parameter On; if VSL is not an option, you will need to unplug the programmer and plug in the seat lift connector in order to verify seat lift operation.

④ Determining motor resistance

If the cold resistance of the traction motor in your application is known, you can enter this value, in milliohms, for the motor resistance (MOTOR R) parameter, and proceed to Step 3. However, we strongly recommend that instead of using the theoretical value provided by the motor manufacturer you use the actual value as determined in the following procedure. It is very important that the motor resistance parameter be set accurately. The correct value for MOTOR R is determined as follows.

④-a. Position the vehicle up against a wall, high curb, or some other immovable object.

④-b. Plug the programmer into the controller and turn on the key-switch.

④-c. In the programmer's Program Menu, set the MAIN C/L parameter to "30" (30 amps).

④-d. In the Test Menu, scroll down to display the Motor R field.

④-e. With the speed limit pot set at maximum, apply the throttle full forward, driving the vehicle against the immovable object.

④-f. Observe the Motor R value displayed in the Test Menu.

④-g. Select the Program Menu, where MOTOR R will appear near the top of the display. Program the MOTOR R parameter to the Motor R value that was displayed in the Test Menu.

④-h. Before moving on to Section 5, Vehicle Performance Adjustment, be sure to set the MAIN C/L back to its default setting.

5

VEHICLE PERFORMANCE ADJUSTMENT

The 1228 controller is a very powerful vehicle control system. Its wide variety of adjustable parameters allow many aspects of vehicle performance to be optimized. Once a vehicle/motor/controller combination has been tuned, the parameter values can be made standard for that system or vehicle model. Any changes in the motor, the vehicle drive system, or the controller will require that the system be tuned again to provide optimum performance.

The tuning procedures should be conducted in the sequence given, because successive steps build upon the ones before. It is important that the effect of these programmable parameters be understood in order to take full advantage of the 1228 controller's powerful features. Please refer to the descriptions of the applicable parameters in Section 3 if there is any question about what any of them do.

Instructions are provided for the following four tuning steps.

- ⑤ **Setting the maximum speeds**
- ⑥ **Setting the acceleration and deceleration rates**
- ⑦ **Adjusting load compensation**
- ⑧ **Fine-tuning the vehicle's response smoothness.**

⑤ Setting the maximum speeds

The four maximum speeds with the speed limit pot in its maximum speed position are set by the speed parameters containing the words MAX SPD:

M1 MAX SPD
M2 MAX SPD
M1 REV MAX SPD
M2 REV MAX SPD

The three maximum speeds with the speed limit pot in its minimum speed position are set by the speed parameters containing the words MIN SPD:

M1 MIN SPD
M2 MIN SPD
REV MIN SPD

Each of the maximum speeds is programmed as a percentage of the maximum possible speed. Set each of the seven maximum speed parameters to give the desired performance.

⑥ Setting the acceleration and deceleration rates

The acceleration and deceleration functions have been designed to provide smooth throttle response when maneuvering at low speeds and snappy throttle response when traveling at high speeds. This is accomplished by defining acceleration/deceleration rates at each end of the speed limit pot's range. The

rates are scaled linearly between these two endpoints. Four pairs of parameters define the endpoints of the acceleration/deceleration curves:

Forward acceleration:	ACCEL MIN SPD and ACCEL MAX SPD
Forward deceleration:	DECEL MIN SPD and DECEL MAX SPD
Reverse acceleration:	REV ACCEL MIN and REV ACCEL MAX
Reverse deceleration:	REV DECEL MIN and REV DECEL MAX.

The programmed acceleration and deceleration rates are independent of mode. However, it makes sense to adjust the low speed rates under the slowest speed conditions (Mode 1) and the high speed rates under the fastest speed conditions (Mode 2). Tuning the rates under the most extreme (slowest, fastest) conditions will most likely result in good performance throughout the entire driving range.

Forward acceleration and deceleration rates

- Ⓒ-a. First, set the ACCEL MIN SPD. Select Mode 1 and set the speed limit pot to its minimum speed position. For low speed testing, we suggest that you drive in a confined area such as an office, where low speed maneuverability is crucial. Depending on how you liked the forward acceleration you experienced, increase or decrease the ACCEL MIN SPD value from its default setting. Smaller values provide faster response. Continue testing and adjusting this value until you are satisfied with the vehicle's low speed forward acceleration behavior.
- Ⓒ-b. Now adjust DECEL MIN SPD, the low speed forward deceleration characteristic. Driving at full throttle with the speed limit pot still in its minimum speed position, release the throttle to neutral. Depending on how you liked the deceleration you experienced, increase or decrease the DECEL MIN SPD value from its default setting. Smaller values provide faster response. Continue testing and adjusting this value until you are satisfied with the vehicle's low speed forward deceleration behavior.
- Ⓒ-c. Next, set the ACCEL MAX SPD. Select Mode 2 and set the speed limit pot to its maximum speed position. Apply full throttle. Depending on how you liked the forward acceleration you experienced, increase or decrease the ACCEL MAX SPD value from its default setting. Smaller values provide faster response. Continue testing and adjusting this value until you are satisfied with the vehicle's high speed forward acceleration.
- Ⓒ-d. Driving at full throttle with the speed limit pot still in its maximum speed position, release the throttle to neutral. Depending on how you liked the deceleration you experienced, increase or decrease the DECEL MAX SPD value from its default setting. Smaller values provide faster response. Continue testing and adjusting this value until you are satisfied with the vehicle's high speed forward deceleration behavior.

Reverse acceleration and deceleration rates

- Ⓒ-e. First, set the REV ACCEL MIN. Select Mode 1 and set the speed limit pot to its minimum speed position. For low speed testing, we suggest that you drive

in a confined area such as an office, where low speed maneuverability is crucial. Depending on how you liked the acceleration you experienced while driving in reverse, increase or decrease the REV ACCEL MIN value from its default setting. Smaller values provide faster response. Continue testing and adjusting this value until you are satisfied with the vehicle's low speed reverse acceleration behavior.

- ⑥-f. Now adjust REV DECEL MIN, the low speed reverse deceleration characteristic. Leaving the speed limit pot in its minimum speed position, drive in reverse at full throttle and then release the throttle to neutral. Depending on how you liked the deceleration you experienced, increase or decrease the REV DECEL MIN value from its default setting. Smaller values provide faster response. Continue testing and adjusting this value until you are satisfied with the vehicle's low speed reverse deceleration behavior.
- ⑥-g. Next, set the REV ACCEL MAX. Select Mode 2 and set the speed limit pot to its maximum speed position. Driving in reverse, apply full throttle. Depending on how you liked the reverse acceleration you experienced, increase or decrease the REV ACCEL MAX value from its default setting. Smaller values provide faster response. Continue testing and adjusting this value until you are satisfied with the vehicle's high speed reverse acceleration.
- ⑥-h. Leaving the speed limit pot in its maximum speed position, drive in reverse at full throttle and then release the throttle to neutral. Depending on how you liked the deceleration you experienced, increase or decrease the REV DECEL MAX value from its default setting. Smaller values provide faster response. Continue testing and adjusting this value until you are satisfied with the vehicle's high speed reverse deceleration behavior.

Fine tuning the acceleration and deceleration rates

- ⑥-i. Drive around in both Mode 1 and Mode 2, while varying the position of the throttle and the speed limit pot. In most cases, setting the acceleration and deceleration rates as described in Steps 6-a through 6-h will provide good performance throughout. However, you may want to make further adjustments to them.
- ⑥-j. In rare cases, it may be desirable to adjust the RAMP SHAPE parameter. This parameter can be used, for example, to extend the throttle's gentle acceleration range to further enhance maneuverability in confined areas. See page 26 for a detailed description of the ramp shape options.

Emergency stop deceleration rate

The E STOP function is invoked when the vehicle is moving forward and the throttle makes a fast transition through neutral to a >80% reverse throttle request. This provides a way to stop more quickly when unexpected conditions arise. When the E STOP function engages, its programmed value becomes the new forward deceleration rate, replacing the regular forward deceleration rate.

- ⑥-k. Drive fast and suddenly release the throttle. You will experience the deceleration behavior determined by the forward deceleration rate.

- ⑥-l. Return to fast speed operation, and this time throw the throttle into >80% reverse. Now you are experiencing the deceleration behavior determined by the E STOP rate.
- ⑥-m. Adjust the E STOP value to produce the desirable “feel” for emergency stops: typically as fast as possible without making the vehicle unstable.
- ⑥-n. Note that the E STOP rate should always be faster than (or equal to) the fastest forward deceleration rate, DECEL MAX SPD.

⑦ Adjusting load compensation

The IR COMP COEFF parameter is used to set the percentage of the maximum motor resistance that will be applied, i.e., $(\text{IR COMP COEFF}) \times (\text{MOTOR R})$, to compensate for increased load caused by uneven terrain.

The trade-off in setting this parameter is that as ability to overcome load disturbances increases, operating smoothness decreases. A high IR COMP COEFF value will allow the vehicle to continue creeping at a low speed, even though it has just contacted a bump in the threshold of a doorway. But if IR COMP COEFF is set too high, it may make the vehicle “jumpy” during normal driving. Small throttle movements in this case may no longer provide gentle linear acceleration, but instead initiate accelerations with a sharp jerk. Therefore, the tuning goal is a balance between adequate load disturbance response and normal acceleration/deceleration response.

The normal range for IR COMP COEFF is approximately 50–80%. Larger numbers provide stiffer, stronger response. If the value needs to be much larger or smaller than this range to achieve acceptable performance, the MOTOR R has probably not been set up correctly and should be checked. Note: Largely different settings for IR COMP COEFF will affect the maximum speeds that were set in Step 5. Therefore, if you make large changes to IR COMP COEFF, you should repeat Step 5.

Assuming that MOTOR R is set correctly (within 10–20%), some general rules of thumb apply:

- ⑦-a. If the vehicle rolls the other direction near the end of a stop on flat ground, IR COMP COEFF is set too high.
- ⑦-b. If the vehicle seems to decelerate to a stop in a nonlinear fashion, IR COMP COEFF could be set too high.
- ⑦-c. If the vehicle is extremely “jumpy” (i.e., responds abruptly to small throttle changes, IR COMP COEFF could be set too high.
- ⑦-d. If the vehicle is still moving on a modest ramp when the brake gets set, IR COMP COEFF is set too low.
- ⑦-e. If the vehicle speed varies dramatically when cresting a hill, IR COMP COEFF is most likely set too low.

⑧ Fine-tuning the vehicle's response smoothness

Three additional functions—gear soften, soft start, and tremor compensation—are available for softening and smoothing vehicle response. In most cases, these functions can be used to maintain a high degree of responsiveness, while still providing smooth vehicle operation.

Gear soften and soft start

These two parameters can be set from 0–100%, with 100% providing a great deal of softening and 0% eliminating the function. They have by far the most noticeable effect on older, worn transaxles.

- ⑧-a. Make sure the GEAR SOFTEN and SOFT START parameters are set to 0%.
- ⑧-b. While driving at both high and low speeds, release the throttle to neutral and then reapply it before coming to a complete stop. Notice how the transaxle gears bump as you reapply the throttle.
- ⑧-c. Change the GEAR SOFTEN parameter from 0% to 100% and repeat the same exercise. Notice how the slop transition is softened, at the expense of a small bit of nonlinearity in the acceleration rate.
- ⑧-d. Adjust the GEAR SOFTEN parameter until you find a setting you like, noting that you probably won't notice much of a difference if you're using a brand new, tight transaxle. Some users prefer a softened feel, while others prefer this parameter set to zero because they want complete linearity in response. In setting this parameter, you also may want to take into consideration that softened slack take-up is easier on the transaxle gears and may extend the transaxle operating life.
- ⑧-e. The soft start function is the same as gear soften, except that it applies to accelerations from zero speed. Note that you'll feel a transaxle bump only if the gears are meshed in the opposite direction when torque is applied, so you may need to nudge the vehicle backwards against the brake when experimenting with this parameter. We recommend relatively small values for the SOFT START parameter (typically < 40%) to avoid excessive delay from a stop. Having separate parameters for the soft start and gear soften functions allows you to set the SOFT START parameter lower than the GEAR SOFTEN parameter. Setting the two parameters the same in effect collapses them into a single parameter.

Tremor compensation

The TREMOR COMP parameter controls vehicle response to sharp throttle movements, such as those resulting inadvertently from hand tremors. This parameter can be set from 1–5, with larger values providing steadier response. The tremor compensation function somewhat overlaps the gear softening functions. However, the tremor compensation function is active all the time, while the two gear softening functions are active only during a gear slack transition, i.e., a torque direction reversal.

Generally, we recommend that you do all your tuning with the TREMOR COMP parameter set to 4 and then either leave it at 4 or adjust it down to 3 or up to 5 as the final piece of tuning. Tremor compensation is most noticeable when the throttle is moved quickly from full to small (but non-neutral) values. The function is bypassed in the neutral state to ensure responsive linear deceleration when the driver commands a stop.

6

PROGRAMMER MENUS

The universal handheld Curtis programmers allow you to program, test, and diagnose Curtis programmable controllers. For information about 1311 programmer operation, see Appendix B. If you are using the older 1307 programmer, consult your existing documentation if necessary.

Note that depending on the specific 1228 model you have, some of the menu items may not appear.

1228 PROGRAM MENU *(not all items available on all controllers)*

MAIN C/L	Main current limit for drive and regen braking, in amps
MOTOR R	Cold resistance of motor, in milliohms
IR COMP COEFF	IR compensation factor: 0–100%
KEY OFF DECEL	Deceleration rate when keyswitch is turned off, in seconds
TREMOR COMP	Tremor compensation: 1–5
ACCEL MAX SPD	Acceleration rate at maximum throttle requests, in seconds
ACCEL MIN SPD	Acceleration rate at minimum throttle requests, in seconds
DECEL MAX SPD	Deceleration rate at maximum throttle requests, in seconds
DECEL MIN SPD	Deceleration rate at minimum throttle requests, in seconds
E STOP	Emergency deceleration rate, in seconds
REV ACCEL MAX	Reverse accel rate at maximum throttle requests, in seconds
REV ACCEL MIN	Reverse accel rate at minimum throttle requests, in seconds
REV DECEL MAX	Reverse decel rate at maximum throttle requests, in seconds
REV DECEL MIN	Reverse decel rate at minimum throttle requests, in seconds
M1 MAX SPD	Mode 1 max. speed with speed pot at max, as % available
M2 MAX SPD	Mode 2 max. speed with speed pot at max, as % available
M1 MIN SPD	Mode 1 max. speed with speed pot at min, as % available
M2 MIN SPD	Mode 2 max. speed with speed pot at min, as % available
M1 REV MAX SPD	Mode 1 max. reverse speed with speed pot at max, as % available
M2 REV MAX SPD	Mode 2 max. reverse speed with speed pot at max, as % available
REV MIN SPD	Maximum reverse speed with speed pot at min, as % available
GEAR SOFTEN	Softened torque reversals for accel/decel while moving: 0–100%
SOFT START	Softened torque endpoints for accel from zero speed: 0–100%
RAMP SHAPE	Throttle map: 20–70%
AMPERE HOURS	Battery pack capacity, in amp-hours
BDI FULL VLTS	Voltage considered 100% state-of-charge, in volts
BDI EMPTY VLTS	Voltage considered 0% state-of-charge, in volts
BDI RESET	Voltage at which state-of-charge resets to 100%, in volts
SLEEP DLY	Delay before sleep mode, in minutes

Program Menu, cont'd

BRAKE DLY	Delay before engaging electromagnetic brake, in seconds
CREEP SPD	Creep speed, as % available speed
THRTL TYPE	Throttle type ¹
THRTL DEADBAND	Neutral deadband adjustment, as % of active range
THRTL GAIN	Restricted range throttle adjustment: 1–10
THRTL AUTOCAL	Wigwag throttle centering utility: On/Off
SPD SCALER	Maximum voltage that can be applied to motor, in volts
HIGH PEDAL DIS	High pedal disable (HPD): On/Off
FAULT BEEP	Horn if HPD or brake fault: On/Off
BEEPER SOLID	Pin 16 output continuous rather than pulsed: On/Off
SEAT LIFT	Seat lift enable: On/Off
BRAKE FLTS	Electromagnetic brake driver/wiring fault check: On/Off
SL BRAKE FLTS	Electromagnetic brake fault check in seat lift mode: On/Off
VSL	Virtual seat lift enable: On/Off
PUSH SPD	Push speed, as % available speed

Program Menu Notes

¹ Throttle types (see Throttle Wiring in Section 2)

Type 0: wigwag (5k Ω pots or 5V throttles)

Type 1: inverted wigwag (5k Ω pots or 5V throttles)

Type 2: single-ended pots (0–5k Ω)

Type 3: inverted single-ended pots (5k Ω –0)

Type 4: single-ended voltage throttles (0–5V)

Type 5: inverted single-ended voltage throttles (5V–0).

1228 TEST MENU (not all items available on all controllers)

HEAT SINK TEMP	Heatsink temperature, in °C
THROTTLE %	Throttle request: 0–100% of range
SPD LIMIT POT	Speed limit pot rotation: 0–100%
BATT VOLTAGE	Battery voltage across the capacitors
BDI	Battery discharge indicator: % of battery charge
MODE INPUT A	On = Mode 1; Off = Mode 2
REVERSE INPUT	On = reverse is selected
INHIBIT IN	On = operation is inhibited
EM BRAKE DRVR	On = electromagnetic brake is mechanically released
MAIN CONT	On = voltage is applied to main relay coil
MOTOR R	Cold motor resistance, in mΩ
PUSH ENABLE IN	On = push enable switch is closed

1228 DIAGNOSTICS AND DIAGNOSTIC HISTORY

This is a list of the possible messages you may see displayed when the programmer is operating in either of the Diagnostics modes. The messages are listed here in alphabetical order for easy reference.

BRAKE ON FAULT	Electromagnetic brake coil open or driver short
BRAKE OFF FAULT	Electromagnetic brake coil short or driver open
CURRENT SENSE FAULT	A/D current sense voltage out of range
EEPROM FAULT	Error in reading EEPROM locations
HPD	High pedal disable (HPD) fault
HW FAILSAFE	Motor voltage fault
LOW BATTERY VOLTAGE	Battery voltage too low
MAIN CONT FLTS	Main contactor did not close or did not open
MAIN ON FAULT	Main contactor driver failed short
MAIN OFF FAULT	Main contactor driver failed open
NO KNOWN FAULTS	No known faults
OVERVOLTAGE	Battery voltage too high
POWER SECTION FAULT	MOSFET driver fault, or shorted motor wiring
PRECHARGE FAULT	Capacitor bank voltage < minimum operating voltage
PROC/WIRING FAULT	HPD fault present >10 seconds
SPD LIMIT POT FAULT	Speed limit pot input voltage out of range
THERMAL CUTBACK	Cutback, due to over-/under-temperature
THROTTLE FAULT 1	Throttle input voltage out of range

7

DIAGNOSTICS AND TROUBLESHOOTING

The 1228 controller provides diagnostics information to assist technicians in troubleshooting drive system problems. The diagnostics information can be obtained in two ways: reading the appropriate display on the handheld programmer or observing the fault codes issued by the status LED.

PROGRAMMER DIAGNOSTICS

The handheld programmer presents complete diagnostic information in plain language. Faults are displayed in the Diagnostics Menu, and the status of the controller inputs/outputs is displayed in the Test Menu.

Additionally, the Diagnostics History Menu provides a list of the faults that have occurred since the history file was last cleared. Checking (and clearing) the history file is recommended each time the vehicle is brought in for maintenance.

Refer to the troubleshooting chart (Table 3) for suggestions about possible causes of the various faults.

For information on 1311 programmer operation, see Appendix B. If you are using the older 1307 programmer, refer to existing documentation.

LED DIAGNOSTICS

During normal operation, with no faults present, the status LED is steadily on. If the controller detects a fault, the status LED provides two types of information. First, it displays a slow flash (2 Hz) or a fast flash (4 Hz) to indicate the severity of the fault. Slow-flash faults are self-clearing; as soon as the fault is corrected, the vehicle will operate normally. Fast-flash faults (“*” in Table 2) are considered to be more serious in nature and require that the keyswitch be cycled to resume operation after the fault is corrected.

After the severity indication has been active for 10 seconds, the status LED flashes a 2-digit fault identification code continuously until the fault is corrected. For example, code “1,4”—low battery voltage—appears as:

□ □ □ □ □	□ □ □ □ □	□ □ □ □ □
(1 , 4)	(1 , 4)	(1 , 4)

The codes are listed in Table 2. Refer to the troubleshooting chart (Table 3) for suggestions about possible causes of the various faults.

Table 2 STATUS LED FAULT CODES

LED CODES		EXPLANATION	
<i>LED off</i>	■	no power or defective controller	
<i>solid on</i>	□	controller operational; no faults	
1,1	□ □	thermal cutback fault	
1,2	□ □□	throttle fault	
1,3	□ □□□	speed limit pot fault	
1,4	□ □□□□	undervoltage fault	
1,5	□ □□□□□	overvoltage fault	
2,1	□□ □	main contactor driver Off fault	
2,3	□□ □□	main contactor fault	
2,4	□□ □□□	main contactor driver On fault	
*	3,1	□□□ □	HPD fault present for >10 seconds
	3,2	□□□ □□	brake On fault
	3,3	□□□ □□□	precharge fault
	3,4	□□□ □□□□	brake Off fault
	3,5	□□□ □□□□□	HPD (High Pedal Disable) fault
*	4,1	□□□□ □	current sense fault
*	4,2	□□□□ □□	motor voltage fault (hardware failsafe)
* †	4,3	□□□□ □□□	EEPROM fault
*	4,4	□□□□ □□□□	power section fault

* = Must cycle keyswitch to clear.
† = Must use programmer to clear, as follows: select Program Menu, alter data value of any parameter, cycle keyswitch.

NOTE: Only one fault is indicated at a time, and faults are not queued up.

Table 3 TROUBLESHOOTING CHART

LED CODE	PROGRAMMER LCD DISPLAY	EXPLANATION	POSSIBLE CAUSE
1,1	THERMAL CUTBACK	over-/under-temperature cutback	1. Temperature >92°C or < -25°C. 2. Excessive load on vehicle. 3. Operation in extreme environments. 4. Electromagnetic brake not releasing.
1,2	THROTTLE FAULT 1	throttle fault	1. Throttle input wire open or shorted. 2. Throttle pot defective. 3. Wrong throttle type selected.
1,3	SPD LIMIT POT FAULT	speed limit pot fault	1. Speed limit pot wire(s) broken or shorted. 2. Broken speed limit pot.
1,4	LOW BATTERY VOLTAGE	battery voltage too low	1. Battery voltage <17 volts. 2. Bad connection at battery or controller.
1,5	OVERVOLTAGE	battery voltage too high	1. Battery voltage >36 volts. 2. Vehicle operating with charger attached. 3. Intermittent battery connection.
2,1	MAIN OFF FAULT	main contactor driver Off fault	1. Main contactor driver failed open.
2,3	MAIN CONT FLTS	main contactor fault	1. Main contactor welded or stuck open. 2. Main contactor driver fault. 3. Brake coil resistance too high.
2,4	MAIN ON FAULT	main contactor driver On fault	1. Main contactor driver failed closed.
3,1	PROC/WIRING FAULT	HPD fault present for >10 sec.	1. Misadjusted throttle. 2. Broken throttle pot or throttle mechanism.
3,2	BRAKE ON FAULT	brake On fault	1. Electromagnetic brake driver shorted. 2. Electromagnetic brake coil open.
3,3	PRECHARGE FAULT	precharge fault	1. Low battery voltage. 2. KSI and throttle turned on at same time.
3,4	BRAKE OFF FAULT	brake Off fault	1. Electromagnetic brake driver open. 2. Electromagnetic brake coil shorted.
3,5	HPD	HPD (High Pedal Disable) fault	1. Improper sequence of throttle and KSI, push, or inhibit inputs. 2. Misadjusted throttle pot.
4,1	CURRENT SENSE FAULT	current sense fault	1. Short in motor or in motor wiring. 2. Controller failure. *
4,2	HW FAILSAFE	motor voltage fault (hardware failsafe)	1. Motor voltage does not correspond to throttle request. 2. Short in motor or in motor wiring. 3. Controller failure. *
4,3	EEPROM FAULT	EEPROM fault	1. EEPROM failure or fault.
4,4	POWER SECTION FAULT	power section fault	1. EEPROM failure or fault. 2. Short in motor or in motor wiring. 3. Controller failure. *

* Jack up vehicle and retest to confirm diagnosis. Clean connections, inspect system wiring, and retest.

8

MAINTENANCE

There are no user serviceable parts in the Curtis 1228 controller. **No attempt should be made to open, repair, or otherwise modify the controller.** Doing so may damage the controller and will void the warranty. However, it is recommended that the controller's diagnostics history file be checked and cleared periodically, as part of routine vehicle maintenance.

DIAGNOSTIC HISTORY

The handheld programmer can be used to access the controller's diagnostic history file. The programmer will read out all the faults that the controller has experienced since the last time the history file was cleared. The faults may be intermittent faults, faults caused by loose wires, or faults caused by operator errors. Faults such as HPD or overtemperature may be caused by operator habits or by overloading.

After a problem has been diagnosed and corrected, clearing the history file is advisable. This allows the controller to accumulate a new file of faults. By checking the new history file at a later date, you can readily determine whether the problem was indeed completely fixed.

The Fault History file and Clear Fault History are in the programmer's Faults Menu; see Appendix B.

APPENDIX A

VEHICLE DESIGN CONSIDERATIONS REGARDING ELECTROMAGNETIC COMPATIBILITY (EMC) AND ELECTROSTATIC DISCHARGE (ESD)

ELECTROMAGNETIC COMPATIBILITY (EMC)

Electromagnetic compatibility (EMC) encompasses two areas: emissions and immunity. *Emissions* are radio frequency (rf) energy generated by a product. This energy has the potential to interfere with communications systems such as radio, television, cellular phones, dispatching, aircraft, etc. *Immunity* is the ability of a product to operate normally in the presence of rf energy.

EMC is ultimately a system design issue. Part of the EMC performance is designed into or inherent in each component; another part is designed into or inherent in end product characteristics such as shielding, wiring, and layout; and, finally, a portion is a function of the interactions between all these parts. The design techniques presented below can enhance EMC performance in products that use Curtis motor controllers.

Decreasing Emissions

Motor brush arcing can be a significant source of rf emissions. These emissions may be reduced by installing bypass capacitors across the motor wires and/or between each motor wire and the motor frame. If the latter approach is used, the voltage rating and leakage characteristics of the capacitors must be adequate to meet any safety regulations regarding electrical connections between a battery operated circuit and the chassis. The bypass capacitor should be installed as close to the motor as possible, or even inside it, to provide the best performance. Alternatively a ferrite bead can be installed on the wires, as close as possible to the motor. In some instances, capacitors and ferrite beads may both be appropriate. Another option is to choose a motor with a brush material that will result in less arcing to the commutator. Brushes that have been run in for approximately 100 hours will typically generate lower emissions than new brushes because there is less arcing after they are properly seated.

The motor drive output from Curtis controllers can also make a contribution to rf emissions. This output is a pulse width modulated square wave with rather fast rise and fall times that are rich in harmonics. The impact of these switching waveforms can be minimized by making the wires from the controller to the motor as short as possible. Ferrite beads installed on the drive wires can further reduce these emissions. For applications requiring very low emissions, the solution may involve enclosing the controller, interconnect wires, and motor together in one shielded box. The motor drive harmonics can couple to battery supply leads and throttle circuit wires, so ferrite beads may also be required on these other wires in some applications.

Increasing Immunity

Immunity to radiated electric fields can be achieved either by reducing the overall circuit sensitivity or by keeping the undesired signals away from this circuitry. The controller circuitry itself cannot be made less sensitive, since it must accurately detect and process low level signals from the throttle potentiometer. Thus immunity is generally achieved by preventing the external rf energy from coupling into sensitive circuitry. This rf energy can get into the controller circuitry via conducted paths and via radiated paths.

Conducted paths are created by the wires connected to the controller. These wires act as antennas and the amount of rf energy coupled into these wires is generally proportional to their length. The rf voltages and currents induced in each wire are applied to the controller pin to which the wire is connected. Curtis motor controllers include bypass capacitors on the printed circuit board's throttle wires to reduce the impact of this rf energy on the internal circuitry. In some applications, ferrite beads may also be required on the various wires to achieve desired performance levels.

Radiated paths are created when the controller circuitry is immersed in an external field. This coupling can be reduced by enclosing the controller in a metal box. Some Curtis motor controllers are enclosed by a heat sink that also provides shielding around the controller circuitry, while others are unshielded. In some applications, the vehicle designer will need to mount the controller within a shielded box on the end product. The box may be constructed of just about any metal, although steel and aluminum are most commonly used.

Most coated plastics do not provide good shielding because the coatings are not true metals, but rather a mixture of small metal particles in a non-conductive binder. These relatively isolated particles may appear to be good based on a dc resistance measurement but do not provide adequate electron mobility to yield good shielding effectiveness. Electroless plating of plastic will yield a true metal and can thus be effective as an rf shield, but it is usually more expensive than the coatings.

A contiguous metal enclosure without any holes or seams, known as a Faraday cage, provides the best shielding for the given material and frequency. When a hole or holes are added, rf currents flowing on the outside surface of the shield must take a longer path to get around the hole than if the surface was contiguous. As more "bending" is required of these currents, more energy is coupled to the inside surface, and thus the shielding effectiveness is reduced. The reduction in shielding is a function of the longest linear dimension of a hole rather than the area. This concept is often applied where ventilation is necessary, in which case many small holes are preferable to a few larger ones.

Applying this same concept to seams or joints between adjacent pieces or segments of a shielded enclosure, it is important to minimize the open length of these seams. Seam length is the distance between points where good ohmic contact is made. This contact can be provided by solder, welds, or pressure contact. If pressure contact is used, attention must be paid to the corrosion characteristics of the shield material and any corrosion-resistant processes

applied to the base material. If the ohmic contact itself is not continuous, the shielding effectiveness can be maximized by making the joints between adjacent pieces overlapping rather than abutted.

The shielding effectiveness of an enclosure is further reduced when a wire passes through a hole in the enclosure. RF energy on the wire from an external field is re-radiated into the interior of the enclosure. This coupling mechanism can be reduced by filtering the wire at the point where it passes through the boundary of the shield. Given the safety considerations involved with connecting electrical components to the chassis or frame in battery powered vehicles, such filtering will usually consist of a series inductor (or ferrite bead) rather than a shunt capacitor. If a capacitor is used, it must have a voltage rating and leakage characteristics that will allow the end product to meet applicable safety regulations.

The B+ (and B-, if applicable) wires that supply power to the throttle control panel—such as for the keyswitch—should be bundled with the remaining throttle wires so that all these wires are routed together. If the wires to the control panel are routed separately, a larger loop area is formed. Larger loop areas produce more efficient antennas which will result in decreased immunity performance.

ELECTROSTATIC DISCHARGE (ESD)

Curtis motor controllers contain ESD-sensitive components, and it is therefore necessary to protect them from ESD damage. Electrostatic discharge (ESD) immunity is achieved either by providing sufficient distance between conductors and the outside world so that a discharge will not occur, or by providing an intentional path for the discharge current such that the circuit is isolated from the electric and magnetic fields produced by the discharge. In general the guidelines presented above for increasing the radiated immunity will also provide increased ESD immunity.

It is usually easier to prevent the discharge from occurring than to divert the current path. A fundamental technique for ESD prevention is to provide adequately thick insulation between all metal conductors and the outside environment so that the voltage gradient does not exceed the threshold required for a discharge to occur. However, in some scooter applications isolation may not be appropriate; in these cases, connection to chassis ground may be required. If the current diversion approach is used, all exposed metal components must be grounded. The shielded enclosure, if properly grounded, can be used to divert the discharge current; it should be noted that the location of holes and seams can have a significant impact on the ESD suppression. If the enclosure is not grounded, the path of the discharge current becomes more complex and less predictable, especially if holes and seams are involved. Some experimentation may be required to optimize the selection and placement of holes, wires, and grounding paths. Careful attention must be paid to the control panel design so that it can tolerate a static discharge.

APPENDIX B

Curtis 1311 HANDHELD PROGRAMMER

The Curtis 1311 handheld programmer provides programming, diagnostic, and test capabilities for the 1230 controller. The power for operating the programmer is supplied by the host controller via the 4-pin connector, J3. The unit consists of an LCD display, rocker-type keys for navigating through the display and for modifying parameters (+/-), and three keys that can be used as bookmarks.

Multiple versions of the 1311 programmer are available, each of which can adjust the parameters at its own access level and below. A Dealer programmer, for example, can adjust all the Dealer, Service, and User access parameters, but not the OEM access parameters.

Fig. B-1 *Curtis 1311 handheld programmer.*

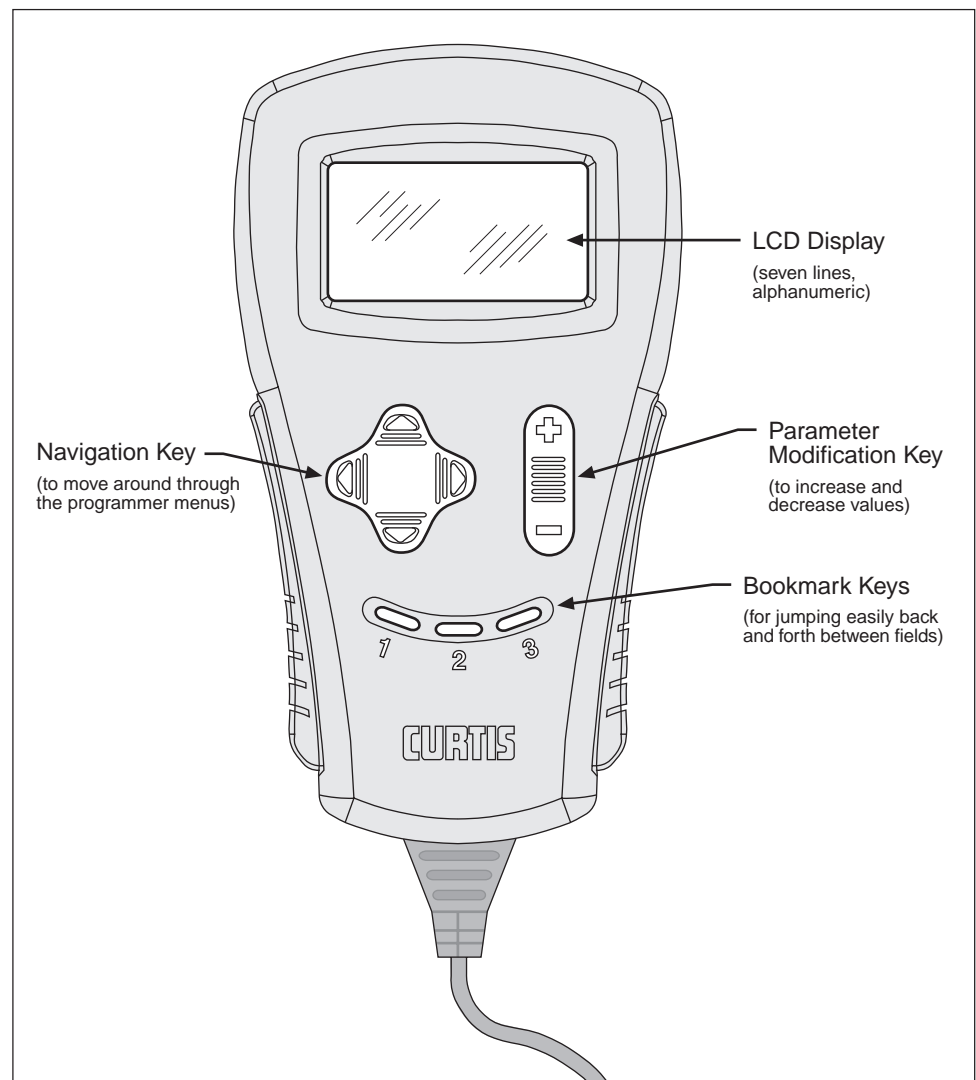

PROGRAMMER OPERATION

The 1311 programmer is easy to use, with self-explanatory functions. After plugging in the programmer, wait a few seconds for it to boot up and gather information from the controller.

For experimenting with settings, the programmer can be left plugged in while the vehicle is driven.

The bookmark keys can make parameter adjustment more convenient. For example, in setting the throttle deadband parameter, you might set a bookmark at this parameter in the Throttle submenu [Program > *Throttle* > Throttle Deadband] and another at the throttle readout [Monitor > *Inputs* > Throttle Input]; this way you can easily toggle between the readout and the parameter.

To set a bookmark, press one of the three bookmark keys for more than 2 seconds. To jump to a bookmarked location, press the appropriate bookmark key quickly (for less than 2 seconds).

PROGRAMMER MENUS

There are six main menus, which in turn lead to nested submenus:

Program — provides access to the individual programmable parameters (see Section 3).

Monitor — presents real-time values during vehicle operation (see Section 4).

Faults — presents diagnostic information, and also a means to clear the fault history file (see Section 7).

Functions — provides access to the controller-cloning commands (see page 44) and to the “reset” command.

Information — displays data about the host controller: model and serial numbers, date of manufacture, hardware and software revisions, and itemization of other devices that may be associated with the controller’s operation.

Programmer Setup — displays data about the programmer: model and serial numbers, date of manufacture, and a list of the programmable parameters that can be accessed with this particular programmer.

APPENDIX C

INDEX TO PROGRAMMABLE PARAMETERS

The 1228's programmable parameters are listed alphabetically in Table C-1, along with cross references to the main entry in the manual. (Note: These parameters are listed in Program Menu order in Section 6, page 40.)

Table C-1 PARAMETER INDEX

PARAMETER	MIN VALUE	MAX VALUE	UNITS	DESCRIPTION IN MANUAL
ACCEL MAX SPD	0.2	4.0	seconds	page 17
ACCEL MIN SPD	0.2	8.0	seconds	page 17
AMPERE HOURS	0	70, 110	amp-hours	page 29
BDI EMPTY VLTS	19.0	24.0	volts	page 30
BDI FULL VLTS	23.4	25.0	volts	page 29
BDI RESET	0.0	40.0	volts	page 30
BEEPER SOLID	OFF/ON		–	page 29
BRAKE DLY	0.0	1.0	seconds	page 20
BRAKE FLTS	OFF/ON		–	page 28
CREEP SPD	0.0	10.0	percent	page 21
DECEL MAX SPD	0.2	4.0	seconds	page 19
DECEL MIN SPD	0.2	8.0	seconds	page 19
E STOP	0.2	4.0	seconds	page 19
FAULT BEEP	OFF/ON		–	page 28
GEAR SOFTEN	0	100	percent	page 18
HIGH PEDAL DIS	OFF/ON		–	page 27
IR COMP COEFF	0	100	percent	page 22
KEY OFF DECEL	0.2	4.0	seconds	page 20
MAIN C/L	30	70, 110	amps	page 17
MAX SPD, M1	20	100	percent	page 20
MAX SPD, M2	15	100	percent	page 20
MIN SPD, M1	0	60	percent	page 21
MIN SPD, M2	0	100	percent	page 21
MOTOR R	0	625	milliohms	page 17
PUSH SPD	25	50	percent	page 21
REV ACCEL MAX	0.2	8.0	seconds	page 18
REV ACCEL MIN	0.2	8.0	seconds	page 18
REV DECEL MAX	0.2	4.0	seconds	page 19
REV DECEL MIN	0.2	8.0	seconds	page 20
REV MAX SPD, M1	15	100	percent	page 21
REV MAX SPD, M2	15	100	percent	page 21
REV MIN SPD	0	40	percent	page 21
RAMP SHAPE	20.0	70.0	percent	page 26
SEAT LIFT	OFF/ON		–	page 28
SL BRAKE FLTS	OFF/ON		–	page 28
SLEEP DLY	0	60	minutes	page 30
SOFT START	0	100	percent	page 18
SPD SCALER	20.0	28.0	volts	page 22
THRTL AUTOCAL	OFF/ON		–	page 23
THRTL DEADBAND	6.0	25.0	percent	page 23
THRTL GAIN	1.0	10.0	–	page 25
THRTL TYPE (*)	0	5	–	page 22
TREMOR COMP	1	5	–	page 30
VSL	OFF/ON		–	page 29

* Throttle types: 0=wigwag, 1=inverted wigwag, 2=0–5k Ω , 3=5k Ω –0, 4=0–5V, 5=5V–0.

APPENDIX D

SPECIFICATIONS

Table D-1 SPECIFICATIONS: 1228 CONTROLLER

Nominal input voltage	24 V and 36 V
PWM operating frequency	15 kHz
Electrical isolation to heatsink	500 V ac (minimum)
Minimum motor resistance	200 m Ω (70 amp models); 130 m Ω (110 amp models)
B+, B- logic pin current (max.)	9 A (pins 1, 2 and 10, 11 on 18-pin connector)
KSI input current (typical)	50 mA without programmer; 150 mA with programmer
KSI input current (peak)	1.5 A
Logic input current (typical)	1 mA at 24 V
Horn output current (max.)	15 mA
BDI output voltage and current (max.)	0–5 V, 2 mA
LED output current (max.)	15 mA
Electromagnetic brake coil resistance	32–200 Ω
Electromagnetic brake current (max.)	1 A
Control input switch type	on/off
Speed control signal	3-wire, 5k Ω ; or 0–5V
Speed control type	single-ended, inverted single-ended, wigwag, or inverted wigwag
Operating ambient temperature range	-25°C to 45°C (-13°F to 113°F)
Storage ambient temperature range	-40°C to 75°C (-40°F to 167°F)
Heatsink overtemperature cutback	linear cutback starts at 92°C (198°F); complete cutoff at 134°C (273°F)
Heatsink undertemperature cutback	50% armature current at -25°C (-13°F)
Package environmental rating	IP40
Weight	0.6 kg (1.3 lb)
Dimensions (L×W×H)	156 × 91 × 43 mm (6.13" × 3.60" × 1.71")
Regulatory compliance	Designed to ANSI RESNA WC 14/21, ISO 7176-14, ISO 7176-21, and EN 12184. Documentation available to support 510K FDA filings.

MODEL NUMBER	NOMINAL BATTERY VOLTAGE (volts)	15 SEC RATING (amps)	1 MIN RATING (amps)	1 HOUR RATING (amps)	VOLTAGE DROP @ 20 AMPS (volts)	UNDER-VOLTAGE CUTBACK (volts)	OVER-VOLTAGE CUTOFF (volts)
1228-24XX	24	70	70 *	35	0.45	17	36
1228-27XX	24	110	75 *	35	0.20	17	36
1228-29XX	24	110	110 *	40	0.15	17	36
1228-34XX	36	70	70 *	35	0.30	17	48

* Actual value of 1-minute rating depends on MOSFET heating.